

ICOM

INSTRUCTION MANUAL

28/50MHz ALL MODE
TRANSCEIVER
IC-575A
IC-575H

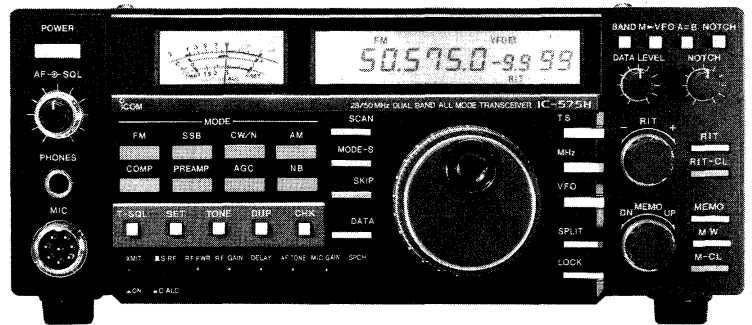

Icom Inc.

FOREWORD

Thank you very much for choosing this Icom product.

The most sophisticated, 28MHz/50MHz dual band all mode transceiver on the market today, the **IC-575A/H** is the result of both advanced Icom engineering and state-of-art computer interface technology from Icom. In addition, the **IC-575A/H** is equipped with Icom's pioneering new DDS (Direct Digital Synthesizer) System, an advanced, computer-developed innovation that enhances the PLL circuit.

To fully understand and appreciate the uses of your new **IC-575A/H** please study this instruction manual carefully prior to operation. Feel free to contact any authorized Icom Dealer or Service Center if you have questions regarding the operation or capabilities of the **IC-575A/H**.

TABLE OF CONTENTS

1. PRECAUTIONS AND PREPARATIONS	1	7. FUNCTIONS OPERATION	30
2. FEATURES	2	7- 1 SPEECH COMPRESSOR OPERATION	30
3. CONTROL FUNCTIONS	4	7- 2 AGC OPERATION	30
3-1 FRONT PANEL	7	7- 3 NOISE BLANKER (NB) OPERATION	30
3-2 FREQUENCY DISPLAY	12	7- 4 RIT OPERATION	31
3-3 REAR PANEL	14	7- 5 DATA SWITCH OPERATION	32
4. INSTALLATION	16	7- 6 NOTCH FILTER OPERATION	32
4-1 PLANNING	16	7- 7 MICROPHONE UP/DOWN OPERATION	33
4-2 MOBILE INSTALLATION	16	7- 8 SWR READING OPERATION	33
4-3 ANTENNA	16	7- 9 DUPLEX OPERATION	34
4-4 GROUNDING	16	7-10 SUBAUDIBLE TONE ENCODER	35
5. INTERCONNECTIONS	17	8. MEMORY AND SCANNING OPERATION	36
5-1 POWER SUPPLY	17	8-1 VFO A AND B SELECTION	36
5-2 LINEAR AMPLIFIER CONNECTION	18	8-2 MEMORY CHANNEL AND VFO SELECTION	36
5-3 AFSK TERMINAL UNIT CONNECTION	18	8-3 MEMORY DATA TRANSFERRING	37
5-4 MIC CONNECTOR INFORMATION	18	8-4 MEMORY PROGRAMMING	37
5-5 ACC(1) SOCKET INFORMATION	19	8-5 MEMORY CLEARING	38
5-6 AQS SOCKET INFORMATION	19	8-6 SCANNING OPERATION	38
5-7 REMOTE CONTROL JACK (CI-V) INFORMATION	20	9. MAINTENANCE AND ADJUSTMENT	41
6. GENERAL OPERATION	21	9-1 MAINTENANCE	41
6-1 INITIAL SETTINGS	21	9-2 ADJUSTMENTS	42
6-2 FREQUENCY SETTINGS	21	10. INSIDE VIEWS	43
6-3 SSB OPERATION	22	11. OPTIONS INSTALLATIONS	44
6-4 CW OPERATION	24	12. BLOCK DIAGRAMS	46
6-5 FM OPERATION	26	13. SPECIFICATIONS	48
6-6 AM OPERATION	28	14. OPTIONS	49
6-7 PACKET AND AMTOR OPERATIONS	29	15. SCHEMATIC DIAGRAM	SEPARATE
6-8 RTTY OPERATION	29		
6-9 SSTV OPERATION	29		

UNPACKING

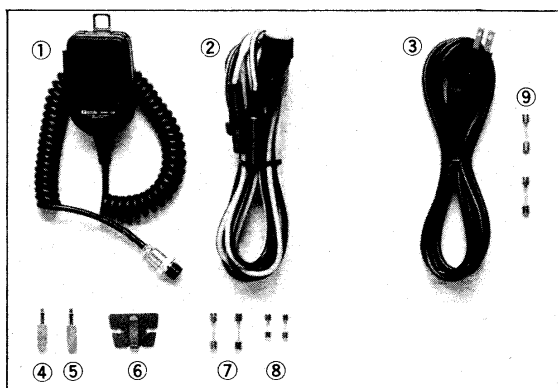

Accessories included with the IC-575A/H

	Qty.
① Microphone*1	1
② DC Power Cable (for IC-575H)	1
③ AC Power Cable (for IC-575A)*2	1
④ External Speaker Plug	1
⑤ Key Plug	1
⑥ Microphone Hanger	1
⑦ Spare Fuses (DC cable, 20A for IC-575H)	2
⑧ Spare Fuses (PA unit, 3A for IC-575H)	2
⑨ Spare Fuses (Rear panel)*3	2

*1 HM-15 for U.K. versions, HM-12 for U.S.A. and Australia versions

*2 Plug type depends on transceiver version

*3 5A for IC-575A U.S.A. version

3A for IC-575A Europe and Australia versions

1. PRECAUTIONS AND PREPARATIONS

■ INSTALLATION LOCATIONS

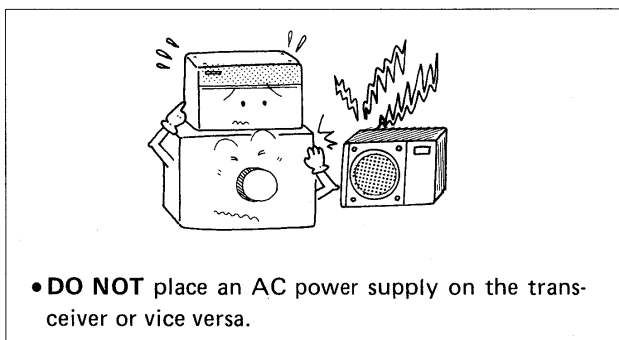
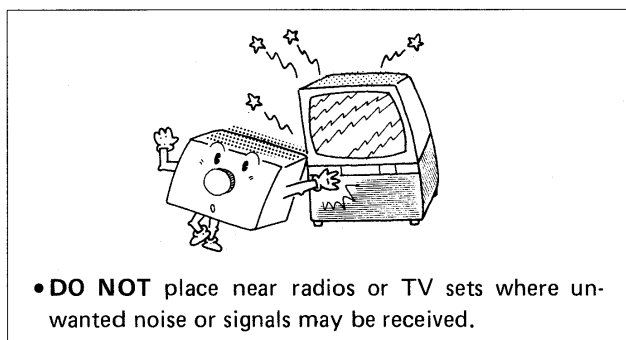
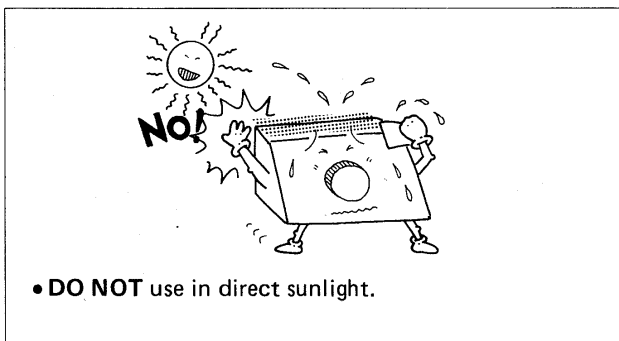
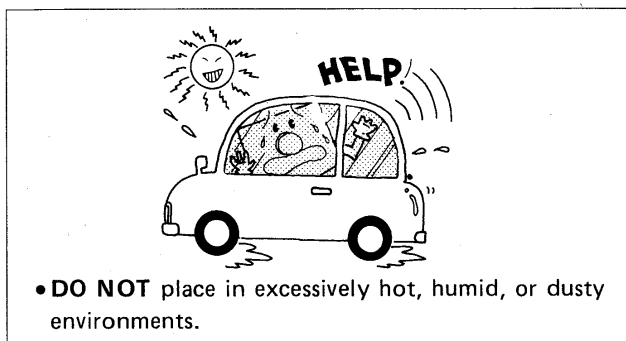

■ GROUNDING

To prevent electrical shocks, TVI, BCI and other problems, be sure to ground the transceiver through the **GROUND TERMINAL**. For best results, use the heaviest gauge wire or strap available and make the connection as short as possible.

ONLY use a city water pipe as a good earth point if the pipe is well grounded and made of metal. **NEVER** use a gas pipe or electrical conduit pipe for grounding.

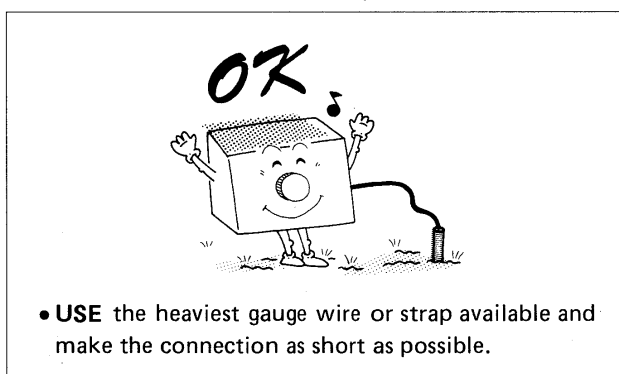
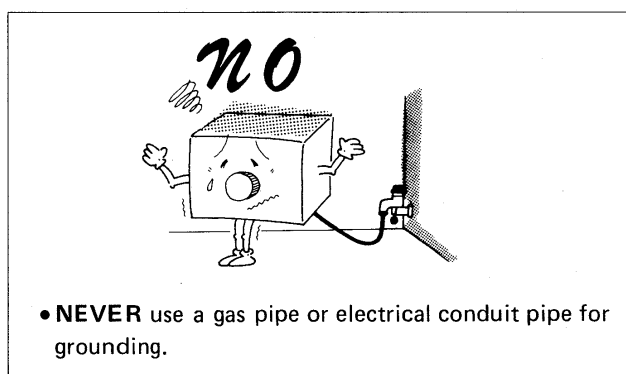

■ OPERATING TEMPERATURE NOTE

The IC-575A/H especially may become hot while transmitting for long periods of time.

WARNING: DO NOT allow babies or small children to touch the IC-575A/H during operations.

2. FEATURES

■ ICOM'S NEWLY DEVELOPED STATE-OF-THE-ART FREQUENCY SYNTHESIZER

The newly developed frequency synthesizer system, the Icom DDS (Direct Digital Synthesizer) unit, provides rapid lockup time. One of the fastest transmit/receive switching times on market, it makes the IC-575A/H ideal for packet and AMTOR communications.

■ HIGH OUTPUT POWER (IC-575H)

The final transistors (2SC2782 x 2) ensure continuous 100W* output power and low IMD (Inter Modulation Distortion) for SSB, CW and FM.

*U.K. version : 50W

■ 28MHz/50MHz DUAL BANDER

The IC-575A/H is compact — only 9.5"(241mm)W x 3.7"(95mm)H x 9.4"(239mm)D — and includes both 28MHz and 50MHz bands. Having dual band capability in one compact unit completely simplifies installation in every mobile and portable situation.

The IC-575A/H can also receive continuously from 26MHz to 56MHz. For example, Public Service Broadcasting (30 ~ 50MHz) can also be heard with the IC-575A/H.

■ NEWLY DEVELOPED ICOM CPU INSTALLED

● Built-in 99-channel large memory capacity

Ninety-nine programmable memories are provided in the IC-575A/H to store frequency, mode, subaudible tone frequency, subaudible tone function ON/OFF, duplex direction, and offset frequency information. These memories are backed up by a lithium backup battery for up to five years.

● Advanced remote control system

Full communications using a personal computer equipped with an RS-232C port are possible by using the serial port mounted on the rear panel of the IC-575A/H. The computer controls frequency, mode, VFO A/B selection, and memories when an appropriate interface is used. The serial port uses a standard 1200bps data transfer.

● Easy-to-read display

An LCD (Liquid Crystal Display) in the IC-575A/H uses a soft orange illumination for easy visibility when operating on bright days. This display indicates the VFO in use, operating mode, memory channel, split mode, scan mode and other information.

● Scanning versatility

The IC-575A/H incorporates a total of four separate scanning functions for easy access to a wide range of frequencies.

- **MEMORY SCAN** repeatedly scans the entire 99-channel memory in sequence.
- **PROGRAMMED SCAN** offers detailed coverage of a specific frequency range through repeated scanning.
- **SELECTED MODE MEMORY SCAN** automatically monitors all memories which contain programmed frequencies with the same mode.
- **SKIP SCAN** allows you to continuously scan your favorite programmed memory channels.

■ OUTSTANDING RECEIVER PERFORMANCE

- **Excellent NOTCH control**

Icom's superb notch filter system ensures strong receiver performances. Clear operating reception is possible even in the presence of a single tone noise.

- **High sensitivity, high dynamic range**

The IC-575A/H RF amplifier uses high quality FETs (2SK125) in parallel connection. These FETs are also used as a balanced-type mixer in the mixer stage, providing high sensitivity and ensuring a very high dynamic range.

- **Built-in RF preamplifier**

The IC-575A/H's built-in RF preamplifier uses a high grade noise figure-type J-FET (2SK152). This ensures RF gain of approximately 10dB and increases receiver ability.

■ COMPLETE 28/50MHz TRANSCEIVER

- **Packet, AMTOR operations**

The rear panel of the IC-575A/H has an easy-to-access terminal socket for AFSK (Audio Frequency Shift Keying) operation. Use the [DATA] SWITCH to rapidly switch between receive and transmit operations. This convenient function is made possible in the IC-575A/H by Icom's exclusive new DDS (Direct Digital Synthesizer) System.

An antenna switching circuit in the IC-575A/H uses a high speed relay for use with data communications such as packet and AMTOR.

- **Full break-in function**

For CW operators, both semi break-in and full break-in are provided for smooth, fast, and natural CW conversations.

■ OPTIONS AVAILABLE

- **EX-20 AUTOMATIC ANTENNA SELECTOR**

Selects two antennas with the band voltage from the IC-575A/H antenna connector.

- **UT-36 VOICE SYNTHESIZER UNIT**

Announces the displayed frequency.

- **UT-34 TONE SQUELCH UNIT**

Provides you with interference-free communications.

- **CT-16 SATELLITE INTERFACE UNIT**

Satellite communication interface unit with IC-275A/E/H or IC-271A/E/H. (The optional UX-14 is required when using CT-16 with IC-271A/E/H.)

- **CT-17 CI-V LEVEL CONVERTER**

Allows connection of the IC-575A/H to a personal computer.

- **FL-100 CW NARROW FILTER**

500Hz/−6dB

- **FL-101 CW NARROW FILTER**

250Hz/−6dB

- **FL-102 AM FILTER**

6kHz/−6dB

- **CR-64 HIGH-STABILITY CRYSTAL UNIT**

±0.5ppm (−30°C ~ +60°C).

- **AH-610 28MHz/50MHz DUAL BAND ANTENNA**

Covers 28MHz and 50MHz bands and operates with one antenna.

3. CONTROL FUNCTIONS

FRONT PANEL

- ④ METER (p. 12)
- ④ TRANSMIT INDICATOR (p. 12)
- ④ RECEIVE INDICATOR (p. 12)

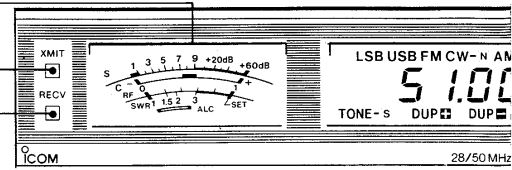

- ① POWER SWITCH (p. 7)
- ② AF GAIN CONTROL (p. 7)
- ③ SQUELCH CONTROL (p. 7)
- ④ PHONES JACK (p. 7)
- ⑤ MIC CONNECTOR (p. 7, 18)

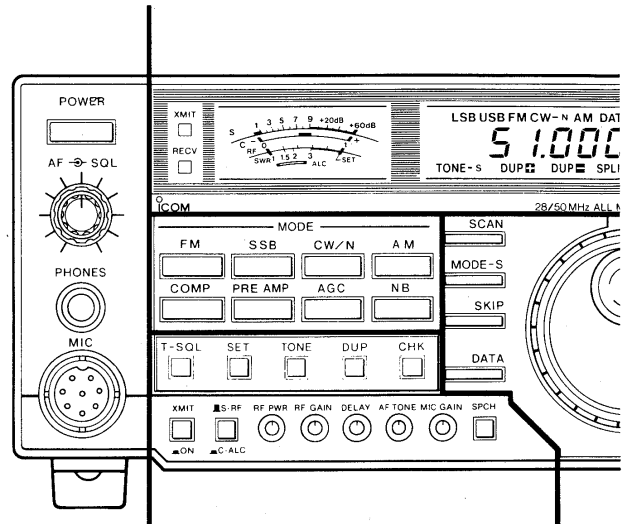
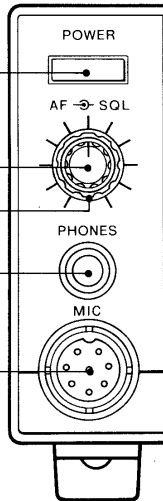

- ⑥ MODE SELECTOR SWITCHES (p. 7)

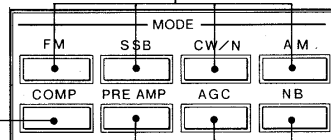

- ⑦ SPEECH COMPRESSOR SWITCH (p. 7, 30)
- ⑧ PREAMP SWITCH (p. 7)
- ⑨ AGC SWITCH (p. 7, 30)
- ⑩ NOISE BLANKER SWITCH (p. 8, 30)

- ⑫ TONE/OFFSET SET SWITCH (p. 8, 34, 35)
- ⑬ SUBAUDIBLE TONE SWITCH (p. 8, 27, 35)
- ⑭ DUPLEX SWITCH (p. 8, 27, 34)
- ⑮ DUPLEX CHECK SWITCH (p. 8, 27)

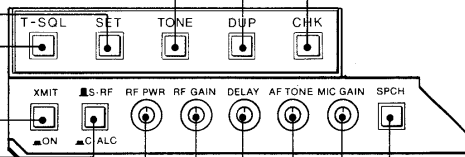

- ⑰ TRANSMIT/RECEIVE SWITCH (p. 8)
- ⑱ RF POWER CONTROL (p. 8)
- ⑲ RF GAIN CONTROL (p. 9)
- ⑳ CW DELAY CONTROL (p. 9, 25)
- ㉑ AF TONE CONTROL (p. 9)
- ㉒ MIC GAIN CONTROL (p. 9)
- ㉓ SPEECH SWITCH (p. 9)

④⑦ FREQUENCY DISPLAY (p. 12)

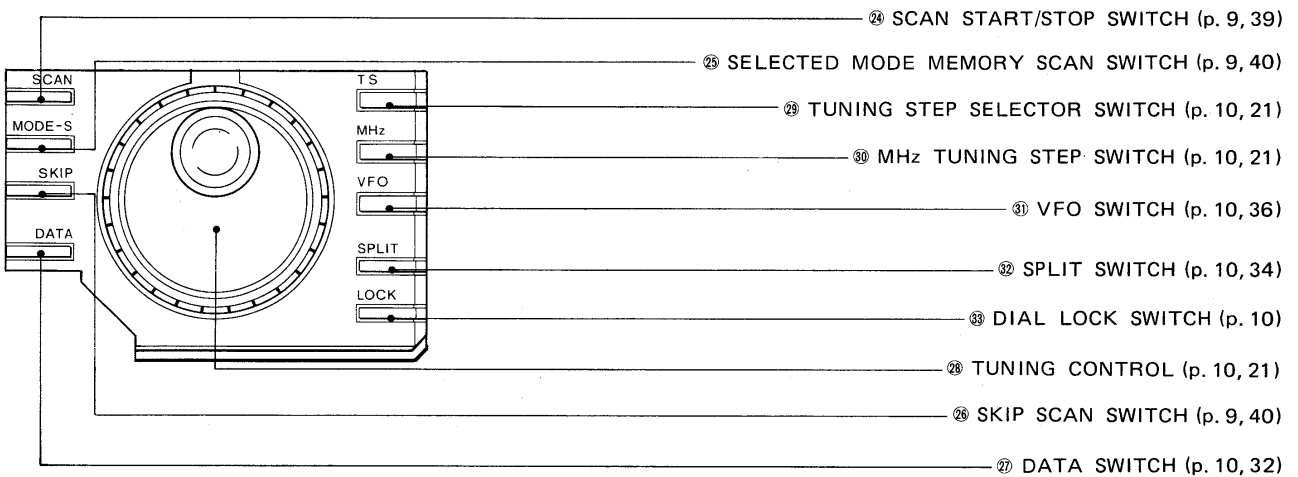
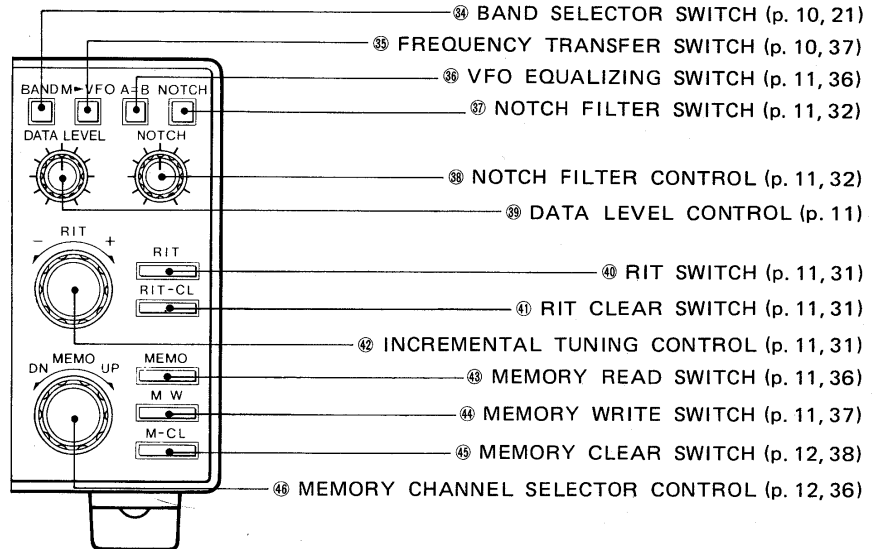
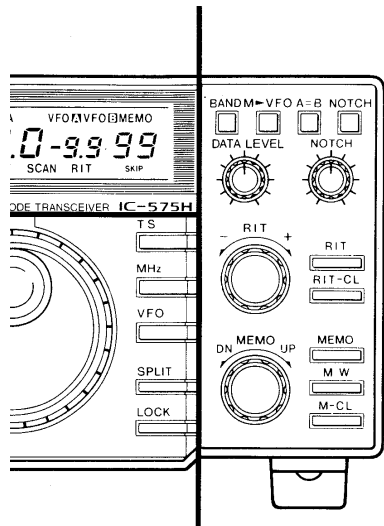
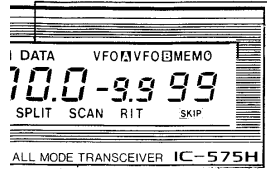

■ FREQUENCY DISPLAY

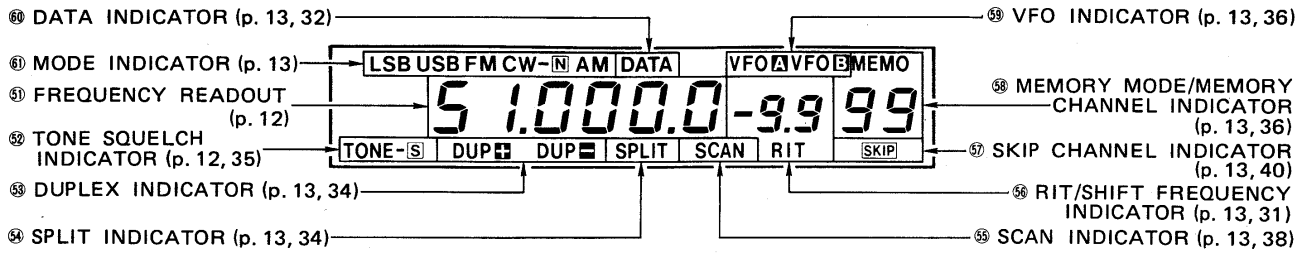

■ REAR PANEL (IC-575A)

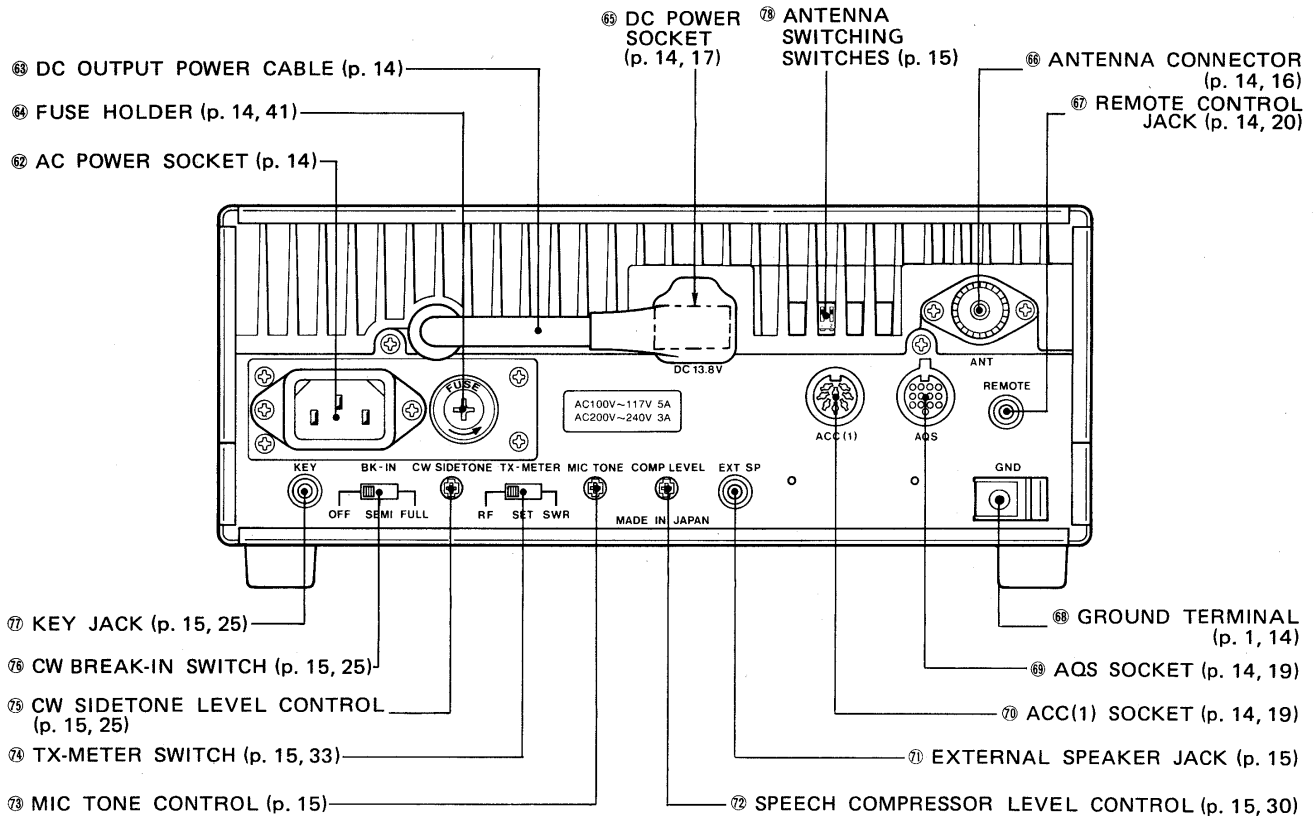

■ REAR PANEL (IC-575H)

NOTE: Refer to the illustration above for a description of the rear panel.

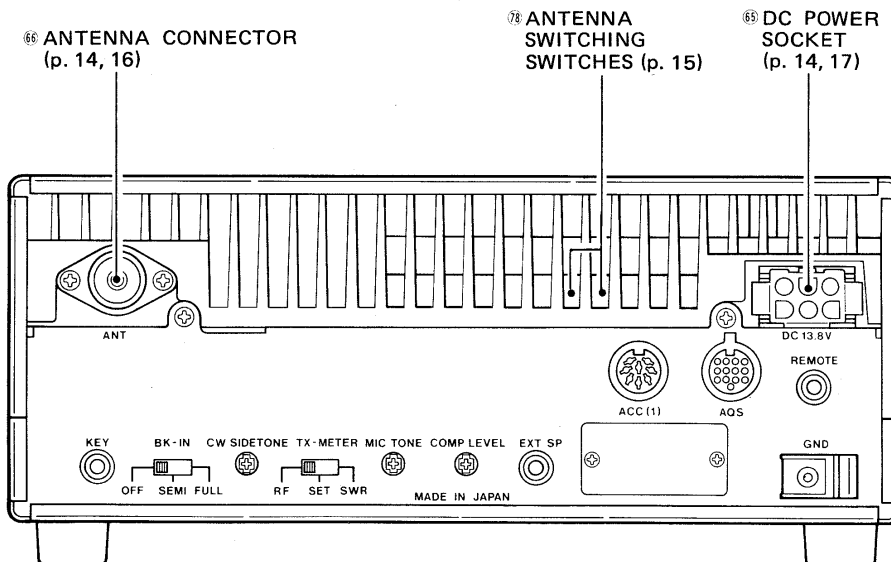

3-1 FRONT PANEL

① POWER SWITCH [POWER]

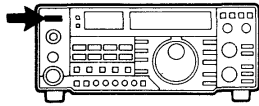

This is a push-lock switch which controls the input power to the transceiver.

② AF GAIN CONTROL [AF]

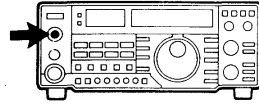

This control varies the audio output level. Clockwise rotation increases the level.

③ SQUELCH CONTROL [SQL]

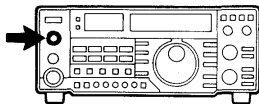

This control sets the squelch threshold level. To turn OFF the squelch function, rotate this control completely counterclockwise. To set the threshold level higher, rotate the control clockwise.

④ PHONES JACK [PHONES]

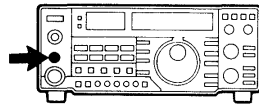

This jack accepts a standard 1/4 inch plug from headphones with an impedance of 4 ~ 16Ω. Stereo headphones may be used without modification.

⑤ MIC CONNECTOR [MIC]

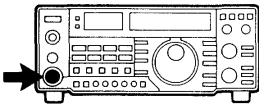

Connect a suitable microphone to this connector. The supplied hand microphone or the optional microphones listed in SECTION 14 OPTIONS are ideal. Pin connections are described on p. 18.

⑥ MODE SELECTOR SWITCHES [FM] [SSB] [CW/N]

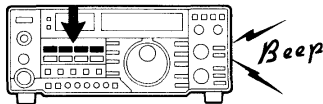

These switches select any of the six operating modes for the IC-575A/H: FM, USB, LSB, CW, CW-Narrow or AM. Push the appropriate switch for the desired mode.

The [SSB] SWITCH repeatedly selects USB and LSB, and the [CW/N] SWITCH selects CW and CW-Narrow.

⑦ SPEECH COMPRESSOR SWITCH [COMP]

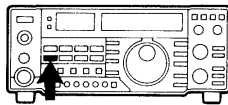

This switch turns the built-in speech compressor circuit ON and OFF. See p. 30 for details.

⑧ PREAMP SWITCH [PREAMP]

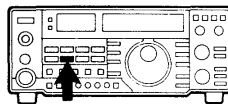

This switch turns the built-in receiver preamplifier circuit ON and OFF.

⑨ AUTOMATIC GAIN CONTROL SWITCH [AGC]

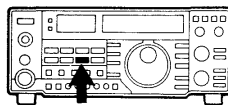

This switch changes the time constant of the AGC circuit. When the switch is OUT, a SLOW time constant is selected. When the switch is IN, a FAST time constant is selected. See p. 30 for details.

⑩ NOISE BLANKER SWITCH [NB]

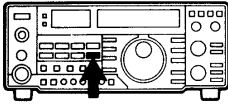

Push this switch IN to reduce pulse-type noise such as that generated by automobile ignition systems. See p. 30 for details.

⑪ TONE SQUELCH SWITCH [T-SQL]

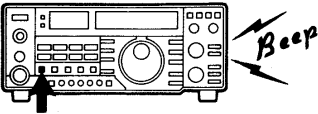

Push this switch to turn ON and OFF the Tone Squelch function alternately when the optional UT-34 TONE SQUELCH UNIT is installed.

⑫ TONE/OFFSET SET SWITCH [SET]

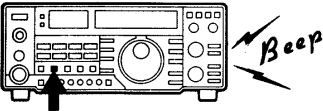

This switch is used to program the subaudible frequency and offset frequency for repeater operation. See p. 34 and p. 35 for programming.

⑬ SUBAUDIBLE TONE SWITCH [TONE]

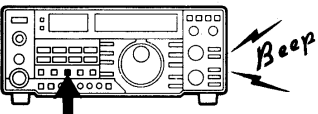

Push to activate the built-in subaudible tone circuit. See p. 27 for operations and p. 35 for programming.

⑭ DUPLEX SWITCH [DUP]

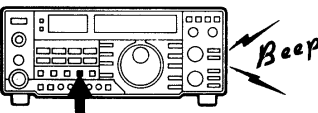

Push this switch to select simplex or duplex mode operation. See p. 27 for operations and p. 34 for programming.

⑮ DUPLEX CHECK SWITCH [CHK]

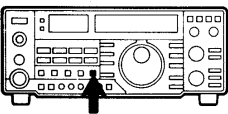

This switch allows the operator to monitor the transmit frequency when duplex mode is selected.

⑯ TRANSMIT/RECEIVE SWITCH

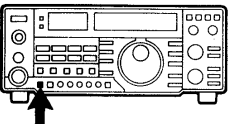

This switch is used to manually switch the transceiver from transmit to receive mode and vice versa.

IN position : Transmit
OUT position : Receive

⑰ METER SWITCH [S-RF] [C-ALC]

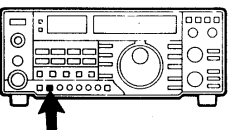

This switch selects the meter function and indicates the following:

SWITCH POSITION	RECEIVING	TRANSMITTING
S-RF (OUT)	Signal strength	*Relative RF output power
C-ALC (IN)	FM : Frequency center SSB CW: Signal strength	ALC level

* The [TX-METER] SWITCH on the rear panel should be in the [RF] position for indicating relative RF output power.

⑱ RF POWER CONTROL [RF PWR]

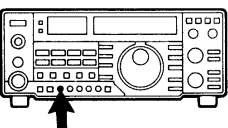

This control varies the RF output power from minimum to maximum continuously. Rotate clockwise to increase output power.

⑱ RF GAIN CONTROL [RF GAIN]

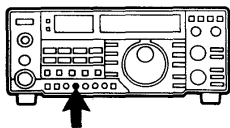

In SSB, CW, AM modes:

This control varies the gain of the RF stage when the transceiver is in receive mode. Rotate clockwise for maximum gain.

NOTE: The transceiver may receive signals that are stronger than the levels shown on the meter.

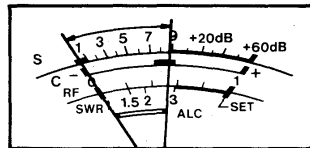

In FM mode:

The control makes the variable attenuator function continuously from 0 to 20dB when the transceiver is in receive mode.

⑳ CW DELAY CONTROL [DELAY]

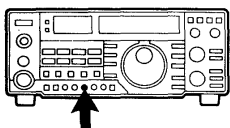

This control changes the transmit to receive switching time during CW semi break-in operation. Adjustment depends on the keying speed used. Clockwise rotation increases the delay time.

㉑ AF TONE CONTROL [AF TONE]

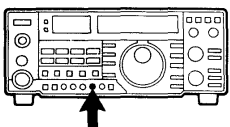

This control varies the receive audio tone. Adjust the control to receive the clearest, most pleasing audio tone.

㉒ MIC GAIN CONTROL [MIC GAIN]

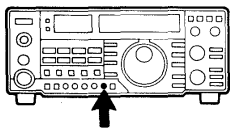

Adjust this control for a suitable modulation level while speaking into the microphone using your normal voice level. Rotate the control clockwise to increase the gain.

㉓ SPEECH SWITCH [SPCH]

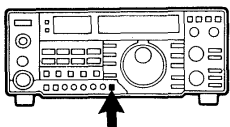

This switch activates the optional UT-36 VOICE SYNTHESIZER UNIT which announces the displayed frequency in English.

㉔ SCAN START/STOP SWITCH [SCAN]

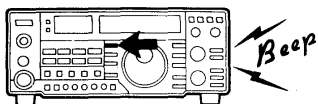

This switch starts and stops all scan functions. See p. 38 ~ 40 for details.

㉕ SELECTED MODE MEMORY SCAN SWITCH [MODE-S]

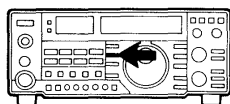

This switch turns ON and OFF the selected mode memory scan function. See p. 40 for details.

㉖ SKIP SCAN SWITCH [SKIP]

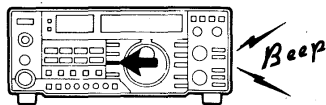

This switch is used for setting the skip channel to be skipped in memory scan. See p. 40 for details.

②⑦ DATA SWITCH [DATA]

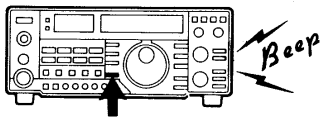

Push this switch to use operating modes such as packet or AMTOR communications which require rapid receive and transmit switching times. See p. 32 for details.

②⑧ TUNING CONTROL

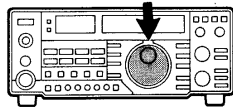

Rotate this control clockwise to increase frequency numbers and counterclockwise to decrease them.

- Quick, continuous rotation of the TUNING CONTROL changes the frequency up or down by 10kHz. Slow rotation changes it by 2.5kHz, except when using FM mode.

②⑨ TUNING STEP SELECTOR SWITCH [TS]

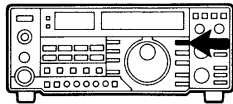

Push this switch to increase the tuning step by 1kHz while operating in any mode. Push and release the switch again to return to the previous tuning step.

POSITION	FM	USB/LSB/CW
OUT	5kHz	10Hz
IN	1kHz	1kHz

③⑩ MHz TUNING STEP SWITCH [MHz]

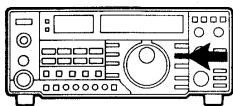

This switch sets the tuning step rate for 1MHz steps in any mode.

③① VFO SWITCH [VFO]

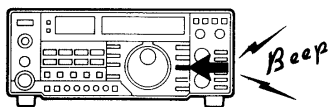

This switch selects VFO A or VFO B for tuning purposes. Each push of this switch selects one of the two VFOs alternately.

This switch also selects VFO A or VFO B mode from the MEMORY CHANNEL mode.

③② SPLIT SWITCH [SPLIT]

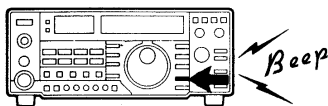

This switch selects the relationship of the two VFO frequencies. When the SPLIT function is activated, one VFO is for receive while the other VFO is for transmit. Each alternate push of this switch chooses the simplex and duplex modes. See p. 34 for details.

③③ DIAL LOCK SWITCH [LOCK]

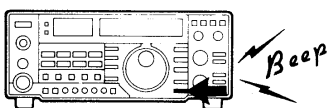

This switch electronically locks the display frequency and deactivates the TUNING CONTROL. Push the switch IN and a beep sound is emitted, indicating that the function has been activated.

③④ BAND SELECTOR SWITCH [BAND]

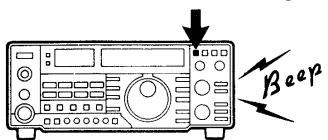

This switch alternately selects the amateur bands, 28MHz and 50MHz quickly.

③⑤ FREQUENCY TRANSFER SWITCH [M ▶ VFO]

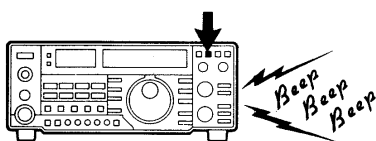

This switch transfers parameters from MEMORY CHANNEL mode to VFO mode. See p. 37 for details.

③⑥ VFO EQUALIZING SWITCH [A=B]

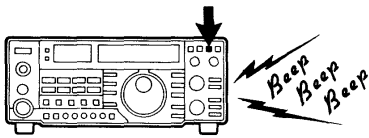

This switch instantly matches the frequency and mode of operation of the two VFOs. See p. 36 for details.

③⑦ NOTCH FILTER SWITCH [NOTCH]

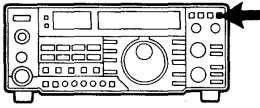

This switch turns the NOTCH FILTER circuit ON and OFF. See p. 32 for details.

③⑧ NOTCH FILTER CONTROL [NOTCH]

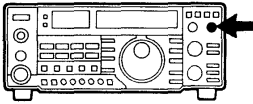

This control shifts the NOTCH FILTER frequency. Adjust the control to reduce or eliminate interfering signals.

③⑨ DATA LEVEL CONTROL [DATA LEVEL]

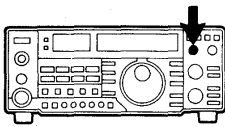

This control adjusts input level from the ACC(1) SOCKET (pin 4). Adjust the control when connecting an external equipment such as a packet.

④① RIT SWITCH [RIT]

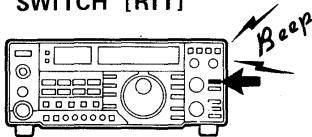

This switch turns the RIT circuit ON and OFF. The "RIT" INDICATOR appears on the FREQUENCY DISPLAY when the RIT function is activated. See p. 31 for details.

④① RIT CLEAR SWITCH [RIT-CL]

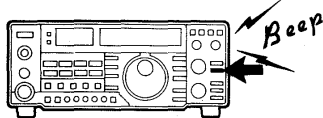

This switch clears the memory which contains frequency shift information and resets the small incremental tuning display to "0.0".

④② INCREMENTAL TUNING CONTROL [- RIT +]

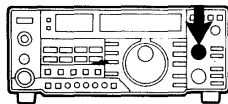

This control shifts the receive frequency by up to 9.99kHz to either side of the frequency indicated on the FREQUENCY DISPLAY.

④③ MEMORY READ SWITCH [MEMO]

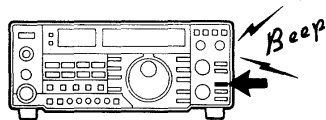

This switch selects MEMORY CHANNEL mode. The "MEMO" INDICATOR appears on the FREQUENCY DISPLAY, and the "VFO A" or "VFO B" INDICATORS disappear. See p. 36 for details.

④④ MEMORY WRITE SWITCH [MW]

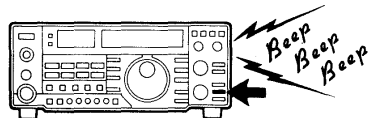

Push this switch to store displayed information in a memory channel. See p. 37 for details.

④5 MEMORY CLEAR SWITCH [M-CL]

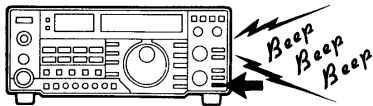

This switch clears unwanted information in any memory channel. When pushed, information in the displayed memory channel is cleared and the memory channel reverts to blank status. See p. 38 for details.

④6 MEMORY CHANNEL SELECTOR CONTROL [MEMO]

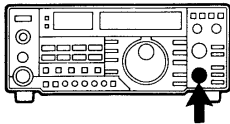

This control is used for selecting memory channels.

④7 FREQUENCY DISPLAY

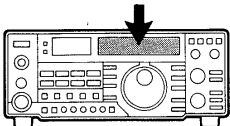

Refer to SECTION 3-2 FREQUENCY DISPLAY for more information.

④8 METER

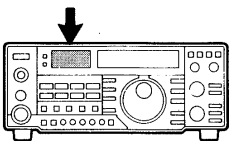

The meter functions as an S-meter or Center meter during receiving, and as an RF-meter or ALC-meter during transmitting. Refer to item ①7 METER SWITCH.

④9 TRANSMIT INDICATOR [XMIT]

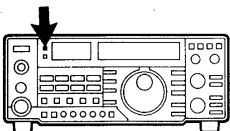

This indicator lights up when the transceiver is in transmit mode.

⑤0 RECEIVE INDICATOR [RECV]

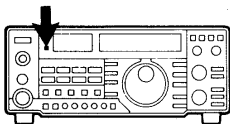

The indicator lights up when the squelch circuit opens.

3-2 FREQUENCY DISPLAY

⑤1 FREQUENCY READOUT

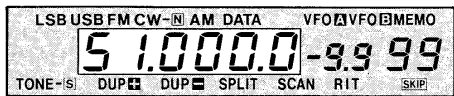

This readout shows the operating frequency using a 6-digit display with 100Hz resolution.

⑤2 TONE SQUELCH INDICATOR



"TONE" appears when the transceiver is activated using the subaudible tone function.

"TONE-S" appears when the transceiver is activated using the Tone Squelch function with an optional UT-34 TONE SQUELCH UNIT.

53 DUPLEX INDICATOR



Either "DUP+" or "DUP-" appears when duplex mode is selected using the [DUP] SWITCH.

54 SPLIT INDICATOR



"SPLIT" appears when separate VFOs are used for the transmit and receive frequencies.

55 SCAN INDICATOR



"SCAN" appears whenever a scan function is selected.

56 RIT/SHIFT FREQUENCY INDICATOR

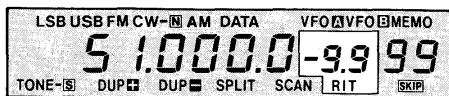

"RIT" and shift frequency appear when the RIT circuit is activated.

57 SKIP CHANNEL INDICATOR

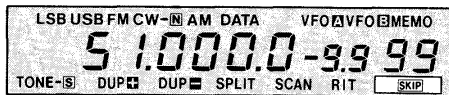

"SKIP" appears when the displayed memory channel is programmed for skip scan.

58 MEMORY MODE/MEMORY CHANNEL INDICATOR



"MEMO" and selected memory channel numbers (1 ~ 99, P1 and P2) appear when MEMORY CHANNEL mode is selected.

59 VFO INDICATOR

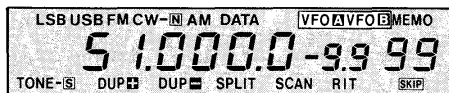

"VFO A" or "VFO B" appears, indicating which VFO is currently selected when operating in VFO mode.

60 DATA INDICATOR



"DATA" appears when the [DATA] SWITCH is pushed.

61 MODE INDICATOR

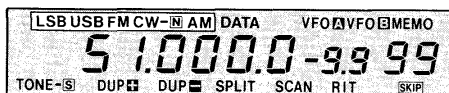

This area of the display shows the operating mode currently selected. The modes available are LSB, USB, FM, CW, CW-Narrow or AM.

3-3 REAR PANEL

⑥2 AC POWER SOCKET

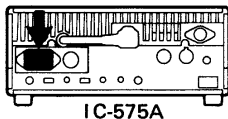

The AC POWER SOCKET connects the transceiver to AC outlets via the supplied AC cable. (IC-575A only)

⑥3 DC OUTPUT POWER CABLE

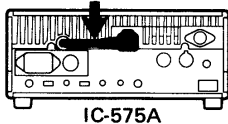

This cable outputs 13.8V DC and is connected to the DC POWER SOCKET as described in item ⑥5 when operating with AC power. (IC-575A only)

⑥4 FUSE HOLDER [FUSE]

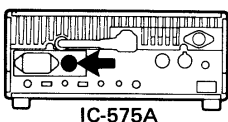

This holder contains the fuses for AC power supply. Use the spare fuses provided to replace an old or damaged fuse. (IC-575A only)

⑥5 DC POWER SOCKET [DC 13.8V]

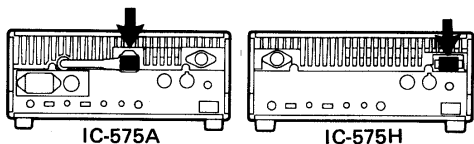

Connect the DC power cable from an external AC power supply. Refer to SECTION 14 for information regarding optional AC power supplies available from Icom.

⑥6 ANTENNA CONNECTOR [ANT]

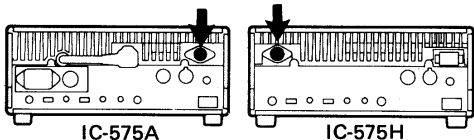

Connect a 50Ω impedance antenna to this connector. The connector should be matched with a PL-259 connector.

⑥7 REMOTE CONTROL JACK [REMOTE]

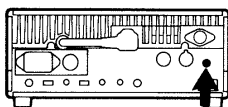

This is a communications port designed for use with a personal computer for remote operation of transceiver functions. The optional CT-17 CI-V LEVEL CONVERTER or CT-16 SATELLITE INTERFACE UNIT is connected here. See p. 20 for details.

⑥8 GROUND TERMINAL [GND]

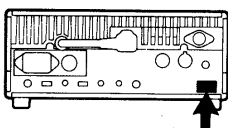

To prevent electrical shocks, TVI, BCI, and other problems, be sure to ground the transceiver through the GROUND TERMINAL.

⑥9 AQS SOCKET [AQS]

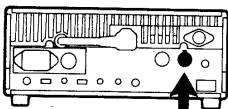

This socket provides signals for AQS (Amateur Quinmatic System). Pin connections are described on p. 19.

⑦0 ACC(1) SOCKET [ACC(1)]

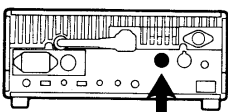

This socket provides signals such as T/R switching, receiver output, ALC input, etc. Pin connections are described on p. 19.

⑦① EXTERNAL SPEAKER JACK [EXT SP]

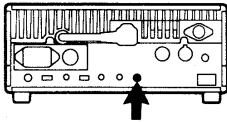

Connect an external speaker to this jack, if required. Use a speaker with an impedance of 4 ~ 16Ω. When using the EXTERNAL SPEAKER JACK, the built-in speaker does not function.

⑦② SPEECH COMPRESSOR LEVEL CONTROL [COMP LEVEL]

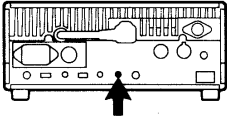

This control varies the compression level when the [COMP] SWITCH is pushed IN. The present circuit gain is approximately 10dB. See p. 30 for details.

⑦③ MIC TONE CONTROL [MIC TONE]

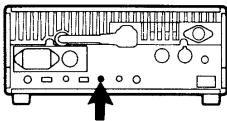

The bass and treble response of your transmitted signal may be altered with this control adjustment.

⑦④ TX-METER SWITCH [TX-METER]

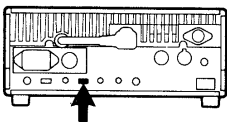

In transmit mode, this switch selects one of three meter functions.

- RF : Indicates relative output power.
- SET : Calibrates the meter to SWR SET position.
- SWR : Indicates the SWR of the antenna system.

⑦⑤ CW SIDETONE LEVEL CONTROL [CW SIDETONE]

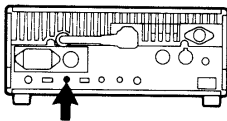

This control changes the audio level of the CW sidetone circuit. Adjust the control for the desired monitor volume.

⑦⑥ CW BREAK-IN SWITCH [BK-IN]

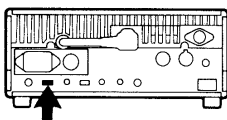

Place this switch in the [FULL] position for full break-in CW operation and in the [SEMI] position for semi break-in operation. Place this switch in the [OFF] position for non CW break-in operation. See p. 25 for details.

⑦⑦ KEY JACK [KEY]

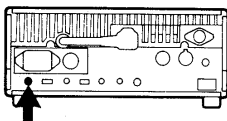

For CW operation, connect a CW key here using the supplied key plug. See p. 25 for details.

⑦⑧ ANTENNA SWITCHING SWITCHES

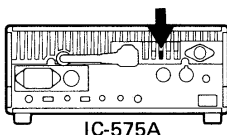

IC-575A

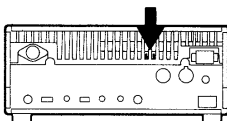
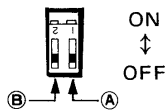

IC-575H

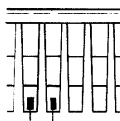

① ② Push ON

These switches control EX-20 AUTOMATIC ANTENNA SELECTOR operation.

- ① BIAS SWITCH : This switch should be ON when using the EX-20 to apply band voltage.
- ② ANTENNA SWITCH : This switch is used to select frequency coverages in the antennas via the [ANT1] and [ANT2] CONNECTORS on the EX-20.

ANTENNA SWITCH	ANT2	ANT1
ON	26 ~ 47MHz	47 ~ 56MHz
OFF	26 ~ 33MHz	33 ~ 56MHz

4. INSTALLATION

4-1 PLANNING

Select a location for your transceiver which allows free access to the front controls, good air circulation and rear clearance for access to the cable connections.

4-2 MOBILE INSTALLATION

An optional IC-MB5 MOBILE MOUNTING BRACKET is available for transceiver mobile installation. Select a location which can support the unit, and does not interfere with your driving in any way.

4-3 ANTENNA

CAUTION: Protect your transceiver from LIGHTNING by using a lightning arrester.

Antennas are very important for ensuring optimum performance in radio communications. We recommend using a 28MHz/50MHz dual band antenna or 2 antennas with an optional EX-20 AUTOMATIC ANTENNA SELECTOR to provide the desired effect. The antenna system should show a VSWR of less than 1:1.5 with a 50Ω coaxial cable.

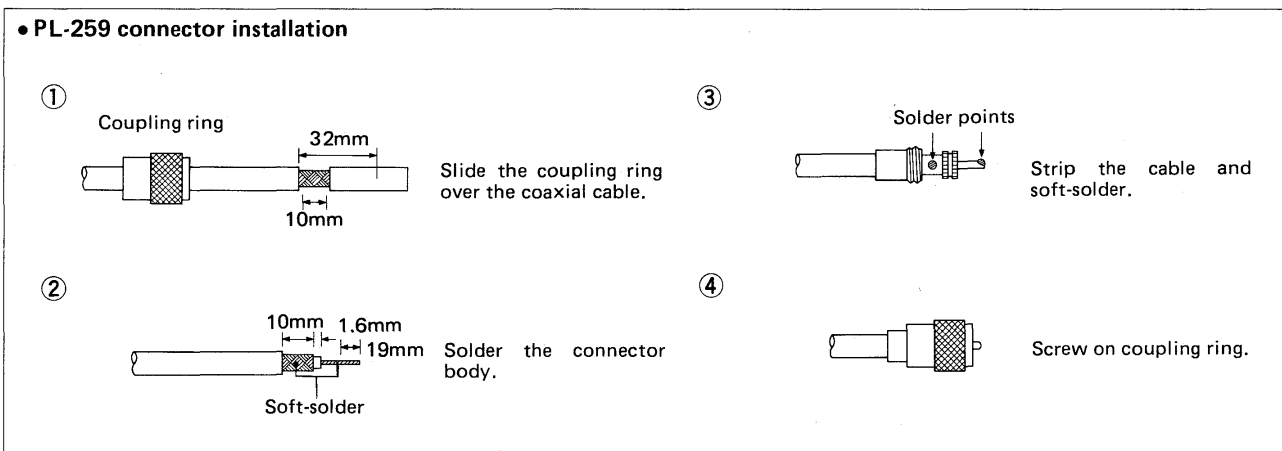
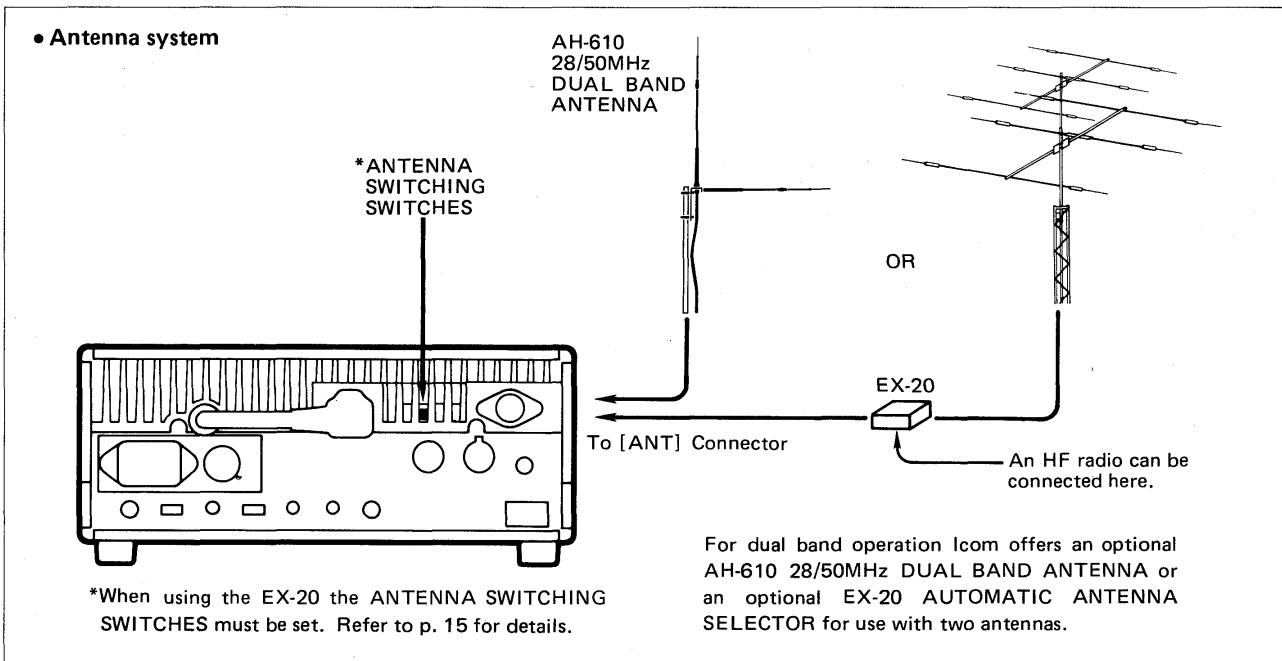

4-4 GROUNDING

To prevent electrical shocks, TVI, BCI and other problems, be sure to ground the transceiver through the GROUND TERMINAL. For best results, use the heaviest gauge wire or strap available and make the connection as short as possible. (See p. 1)

5. INTERCONNECTIONS

5-1 POWER SUPPLY

To power the IC-575A/H from another external power supply or any other DC power source, be sure the output voltage is 12 ~ 15V and current capacity is at least 20A for IC-575H or 10A for IC-575A.

WARNING: Voltages greater than 15V DC may damage this transceiver. Check the source voltage before connecting the power cable when using this transceiver with non-Icom AC power supplies.

● Operation with optional PS-55 AC POWER SUPPLY

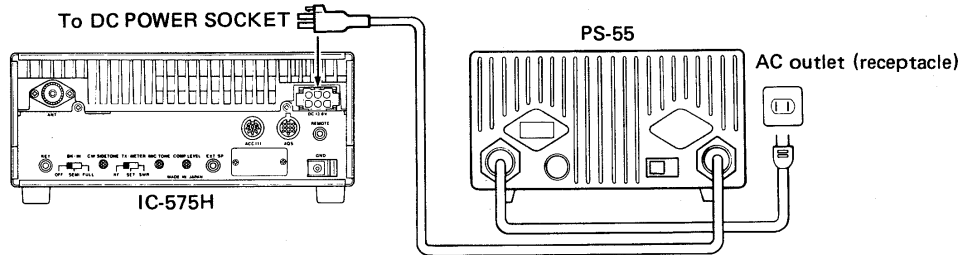

The [POWER] SWITCH synchronizes the PS-55 AC POWER SUPPLY with the IC-575A/H.

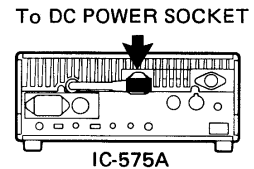
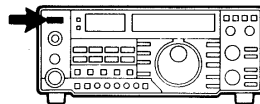

● Operation with non-Icom AC power supplies

Current capacity is at least 20A for IC-575H or 10A for IC-575A.

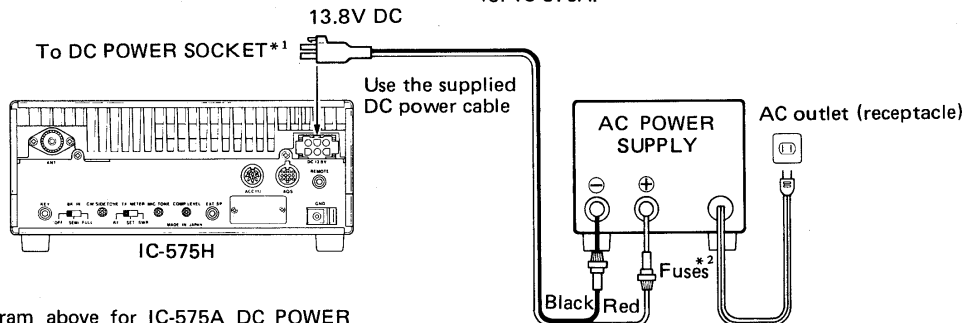

*1 See the diagram above for IC-575A DC POWER SOCKET location.

*2 20A for IC-575H or 10A for IC-575A.

● Operation with a DC power source

Make the shortest possible direct connection to the battery using the supplied power cable.

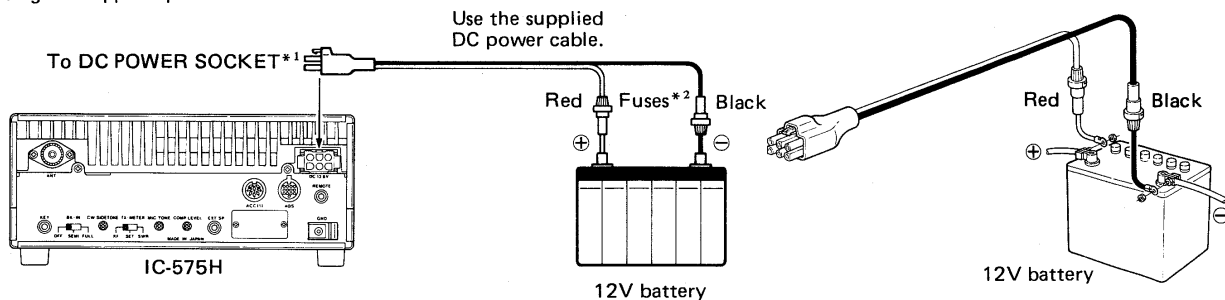

*1 See the diagram above for IC-575A DC POWER SOCKET location.

*2 20A for IC-575H or 10A for IC-575A.

For safety purposes, remember to install fuses in the DC cable if connecting the IC-575A/H to a vehicle battery. Locate the fuses as close to the car battery as possible.

5-2 LINEAR AMPLIFIER CONNECTION

The IC-575A/H is designed to operate into a load with a 50Ω impedance. Any amplifier used should have a 50Ω input impedance for best efficiency.

- 1) Pin 3 (SEND) is grounded when the transceiver is in transmit mode and opens when the transceiver returns to receive mode. The output condition of pin 3 controls either the transmit or receive function of the transceiver.

Specification for the keying rate is 20V DC maximum. **DO NOT** exceed this limit.

- 2) Pin 8 of the ACC(1) SOCKET is an ALC input for the Automatic Level Control signal from an external amplifier.

• Operation with an external linear amplifier

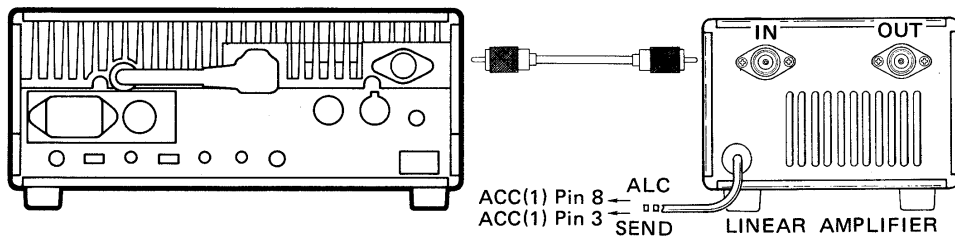

5-3 AFSK TERMINAL UNIT CONNECTION

When operating an AFSK such as RTTY, AMTOR or packet connect the ACC(1) SOCKET as in the diagram below:

• Using the ACC(1) SOCKET

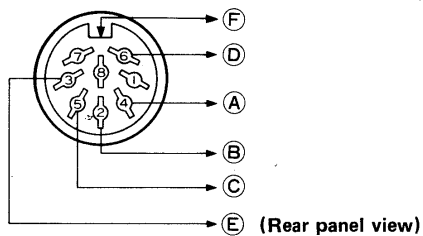

• Using the MIC CONNECTOR

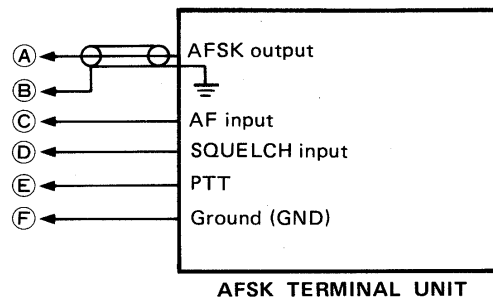
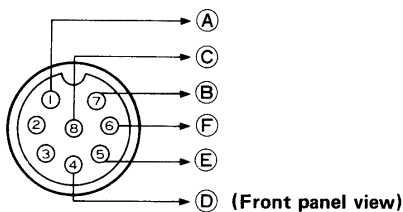

5-4 MIC CONNECTOR INFORMATION

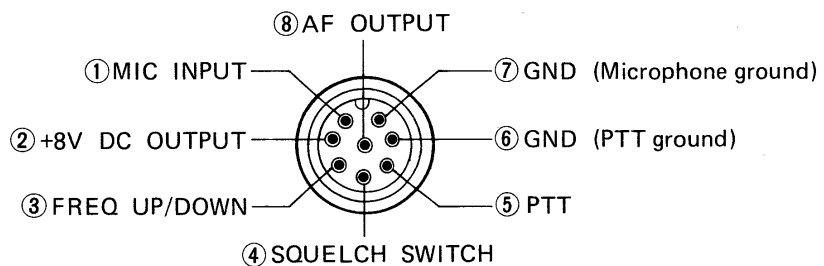

(Front panel view)

5-5 ACC(1) SOCKET INFORMATION

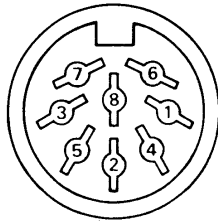

(Rear panel view)

Various signals are available from the ACC(1) SOCKET such as receiver output, modulator input, T/R changeover, etc.

PIN NO.	PIN NAME	DESCRIPTION
1	NC	No connection.
2	GND	Ground.
3	SEND	The transceiver switches to transmit mode when this terminal is grounded. It is grounded when the [XMIT] SWITCH is placed in the IN position.
4	MOD	Connected in the modulator stage. The modulator amplification level can be changed by using the S3 SWITCH. See page 43 for the location of this switch.
5	AF	Output from the receive detector stage. The output level can be changed by using the S4 SWITCH on the MAIN UNIT. See page 43 for the location of this switch.
6	SQLS	This terminal goes to ground level when the squelch opens.
7	13.8V	13.8V DC output is switched by the [POWER] SWITCH on the front panel. Maximum current capacity is 1A.
8	ALC	Input for external ALC voltage.

5-6 AQS SOCKET INFORMATION

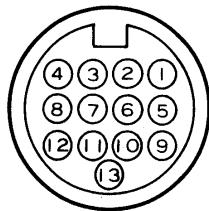

(Rear panel view)

PIN NO.	PIN NAME	DESCRIPTION
1	TX E	Modulator ground.
2	TX MOD	Modulator input.
3	MUTE	MUTE line for audio output and microphone input. The terminal is "LOW" while muting.
4	CAC	Valid signal output for CAC (Channel Access) function. The terminal is "HIGH" when the CAC function is activated.
5	RX AF	Output from the receive detector stage.
6	PTT	Connected to the PTT circuit. The terminal is "LOW" when transmitting.
7	SEND	This is an input terminal that the transceiver switches to in transmit mode when the terminal is "LOW".
8	SEARCH	When searching an empty channel, the terminal is "LOW".
9	E	Demodulator ground.
10	CI-V	This is the CPU I/O terminal for setting the frequency and mode.
11	NC	No connection.
12	RECV	When receiving a signal, this terminal is "LOW".
13	13.8	This terminal outputs 13.8V DC to an AQS adapter.

5-7 REMOTE CONTROL JACK (CI-V) INFORMATION

●CT-17 CONNECTION

Icom has introduced a new remote control Local Area Network, the ICOM COMMUNICATION INTERFACE-V (CI-V) SYSTEM using the CSMA/CD (Carrier Sense Multiple Access with Collision Detection) standard.

- A serial data bus carries all control data. Operation is possible using an optional CT-17 LEVEL CONVERTER with a personal computer equipped with an RS-232C serial port.

Up to four Icom CI-V transceivers can be connected to a personal computer via the CT-17.

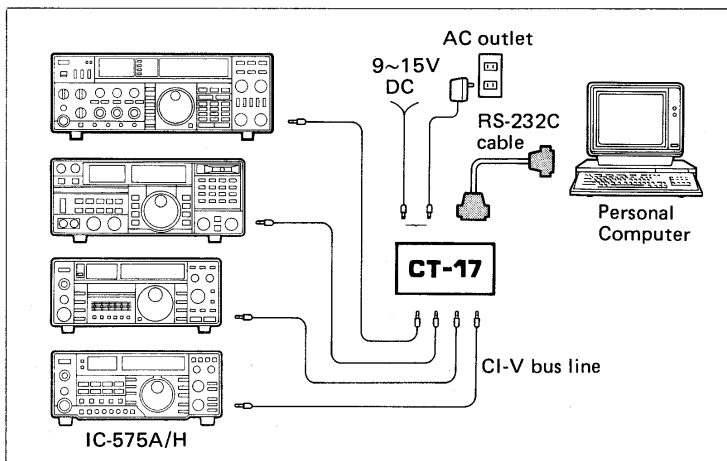

●REMOTE CONTROL DEFAULT SWITCHES

S3 SWITCHES (Switches 1 ~ 10)

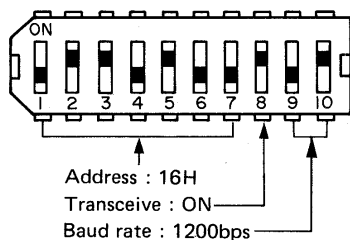

Transmitters and receivers using the Icom CI-V System exchange serial information in the packet format. The contents of a data packet can be changed by using the S3 switches (Switches 1 ~ 10) on the LOGIC UNIT.

Switches 1 ~ 7 (For setting an address with your transceiver):

Switches 2, 3 and 5 in the ON position set an independent address for your IC-575A/H.

The Icom standard address number for the IC-575A/H:

16H (decimals 22)

Switch 8 (For setting a transceive flag):

The ON position sets a flag used for sending code data of transceive operations automatically when the frequency is changed. The receive code data is accepted regardless of whether the switch is ON or OFF.

Switches 9 and 10 (For setting a baud rate):

Baud rate	Switch 9	Switch 10
9600	OFF	OFF
4800	ON	OFF
1200	OFF	ON
300	ON	ON

NOTE: The standard Icom CI-V baud rate is 1200bps.

●SATELLITE COMMUNICATIONS

Satellite communications are possible between the IC-575A/H and IC-275A/E/H or IC-271A/E/H using an optional CT-16 SATELLITE INTERFACE UNIT. (The optional UX-14 is necessary for the IC-271A/E/H).

When using the CT-16, set switches as follows:

- Transceive flag switch (Switch 8) : OFF
- Baud rate (Switch 9: OFF, Switch 10: ON) : 1200bps

6. GENERAL OPERATION

6-1 INITIAL SETTINGS

After all INSTALLATION instructions have been followed in SECTION 4, including connecting an antenna system, set the controls and switches as shown in the diagram below.

CAUTION: Transmitting without an antenna may damage the transceiver.

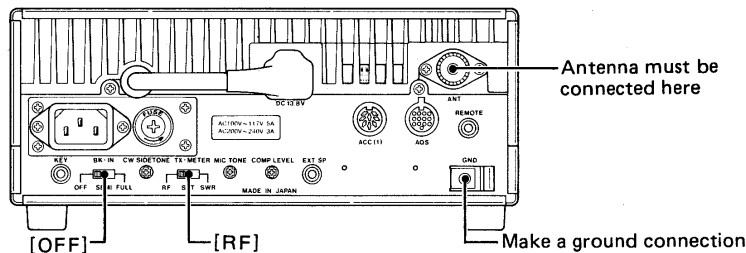
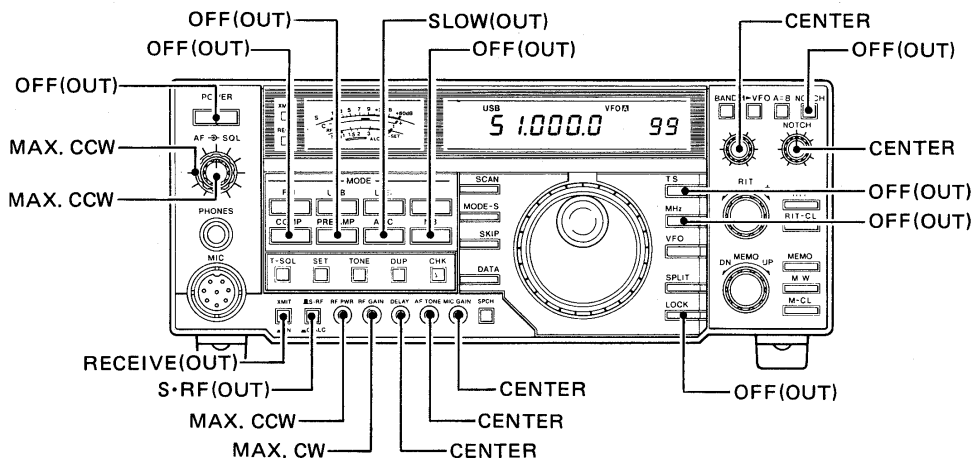

6-2 FREQUENCY SETTINGS

Make sure the [LOCK] SWITCH is in the OUT position before rotating the TUNING CONTROL.

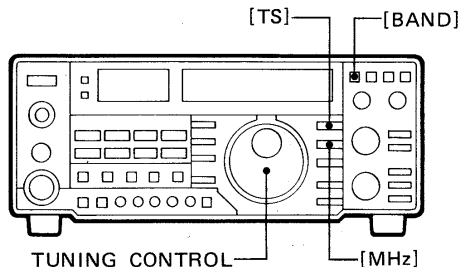

1) TUNING CONTROL:

Rotate the TUNING CONTROL to change the frequency in 10Hz steps while in any operating mode (except FM mode). Turning the TUNING CONTROL faster automatically shifts the tuning increments in 40Hz steps.

2) TUNING SPEED SWITCH [TS]:

When the [TS] SWITCH is pushed IN, the operating frequency shifts in 1kHz increments while in any operating mode as the TUNING CONTROL is turned.

3) MHz TUNING STEP SWITCH [MHz]

When the [MHz] SWITCH is pushed IN, the operating frequency shifts in 1MHz increments while in any operating mode as the TUNING CONTROL is turned.

4) BAND SELECTOR SWITCH [BAND]

Push the [BAND] SWITCH to quickly select the 28MHz or 50MHz band.

6-3 SSB OPERATION

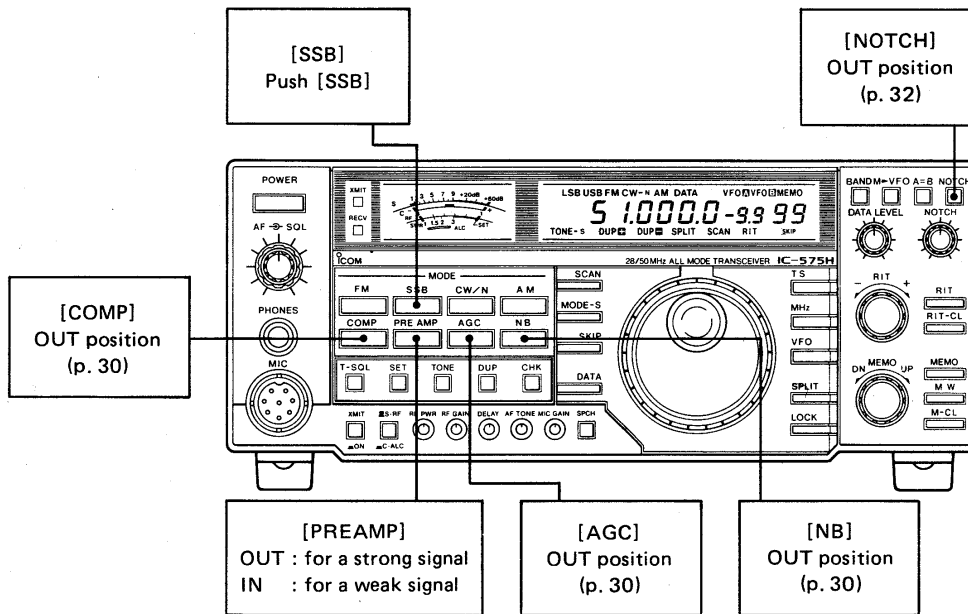

(1) SSB RECEIVING

- 1) Set all controls and switches.
 - 2) Push IN [POWER] SWITCH.
 - 3) Push [SSB] SWITCH.
 - 4) Adjust [AF] GAIN and [SQL] CONTROLS.
 - 5) Rotate TUNING CONTROL and search for a signal.
 - 6) Use Notch Filter.
 - 7) Adjusts [RF GAIN] CONTROL.
 - 8) Push [PREAMP] SWITCH.
- 1) Set all controls and switches as described on p. 21.
 - 2) Push IN the [POWER] SWITCH.
 - 3) Push the [SSB] SWITCH once or twice to alternately select USB or LSB mode.
 - 4) Adjust the [AF] GAIN CONTROL for the desired volume.
Turn the [SQL] CONTROL clockwise until the noise from the speaker is quieted, if required.
 - 5) Rotate the TUNING CONTROL and search for a signal. Tune across the signal to peak the meter needle while listening for the most intelligible audio.
 - 6) The Notch Filter eliminates a single tone signal with interference.
 - 7) If required, turn the [RF GAIN] CONTROL counterclockwise to reduce unwanted weak signals.
 - 8) Push the [PREAMP] SWITCH ON when you wish to receive a weak signal more clearly.

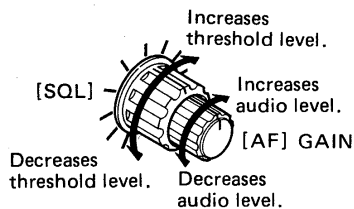

(2) SSB TRANSMITTING

NOTE: Listen carefully before transmitting to be sure your transmission will not interfere with any other communications.

This transceiver transmits in the range 28.0000 ~ 29.700MHz or 50.0000 ~ 54.0000MHz. When attempting to transmit on bands of another frequency, the transceiver transmits no power and the FREQUENCY DISPLAY appears as follows:

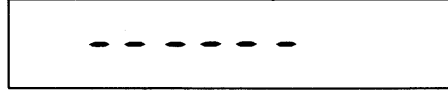

- 1) Select transmit mode.

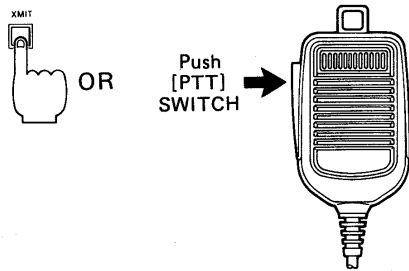

- 1) Select transmit mode using either the [TRANSMIT/RECEIVE] SWITCH or the [PTT] SWITCH.

- 2) Set METER SWITCH to OUT position.



- 2) Set the METER SWITCH to the OUT position. Speak into the microphone using your normal voice level. The meter movement indicates that a signal is being transmitted.

- 3) Adjust [RF PWR] CONTROL.

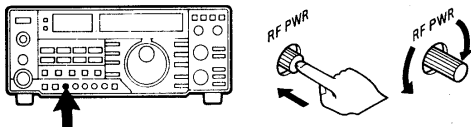

- 3) Adjust the [RF PWR] CONTROL to a suitable output power level.

- 4) Set METER SWITCH to IN position, and adjust [MIC GAIN] CONTROL.



- 4) Set the METER SWITCH to the IN position, and adjust the [MIC GAIN] CONTROL for a meter reading within the ALC zone on voice peaks.

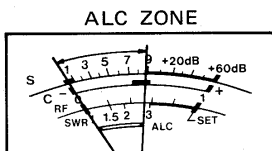

- 5) Use the Speech compressor function.

- 5) Use the Speech compressor function for greater talk power. (See p. 30).

6-4 CW OPERATION

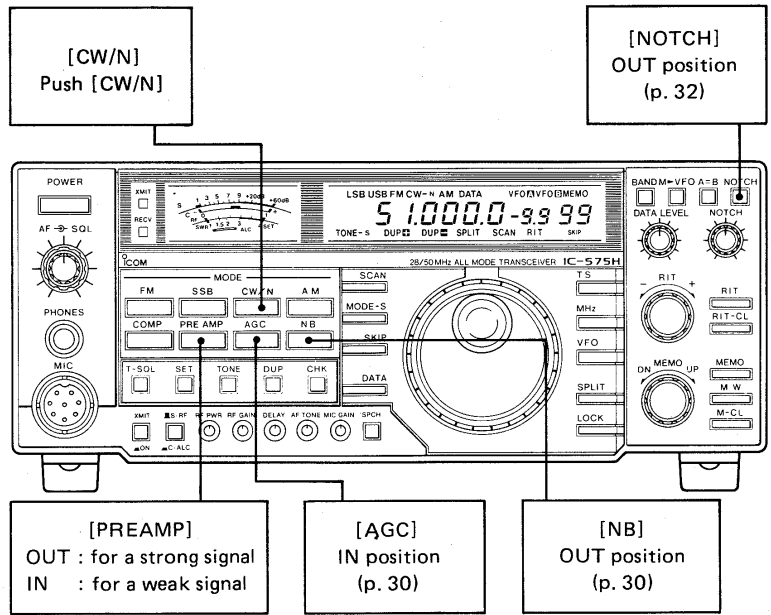

NOTE:
The transceiver cannot transmit on out-of-ham-band frequencies.

(1) CW RECEIVING

- 1) Set all controls and switches.
 - 2) Push IN [POWER] SWITCH.
 - 3) Push [CW/N] SWITCH.
 - 4) Adjust [AF] GAIN and [SQL] CONTROLS.
 - 5) Rotate TUNING CONTROL and search for a signal.
 - 6) Use Notch Filter.
 - 7) Adjust [RF GAIN] CONTROL.
 - 8) Push [PREAMP] SWITCH.
- 1) Set all controls and switches as described on p. 21.
 - 2) Push IN the [POWER] SWITCH.
 - 3) Push the [CW/N] SWITCH once or twice to alternately select CW or CW-Narrow.
 - When an optional CW Narrow filter is not installed, CW-Narrow mode does not operate and no audio is emitted.
 - 4) Adjust the [AF] GAIN CONTROL for the desired volume.

Turn the [SQL] CONTROL clockwise until the noise from the speaker is quieted, if required.
 - 5) Rotate the TUNING CONTROL and search for a signal. Tune across the signal to peak the meter needle while listening for the most intelligible audio.
 - 6) The Notch Filter eliminates a single tone signal with interference.
 - 7) If required, turn the [RF GAIN] CONTROL counterclockwise to reduce the unwanted weak signals.
 - 8) Push the [PREAMP] SWITCH ON when the desired weak signal is received.

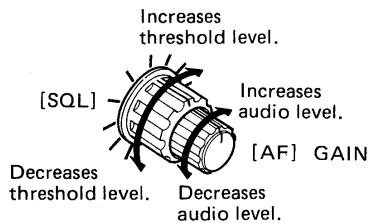

(2) CW TRANSMITTING

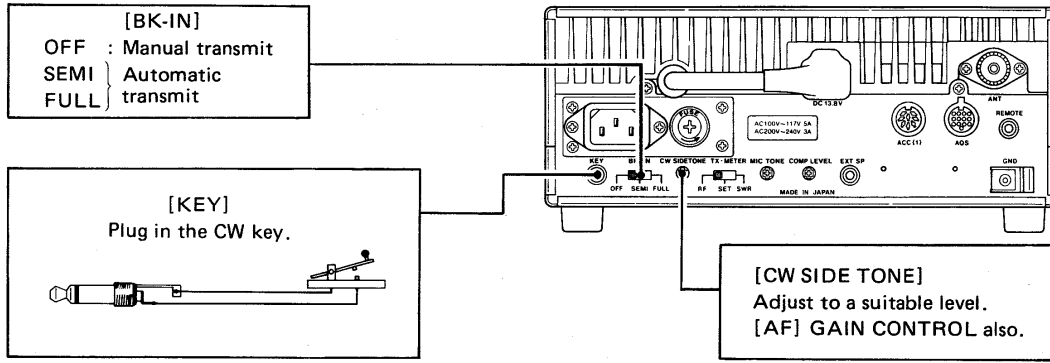

● [BK-IN] : OFF

- 1) Select transmit mode.
- 2) Operate CW key.
- 3) Adjust [RF PWR] CONTROL.

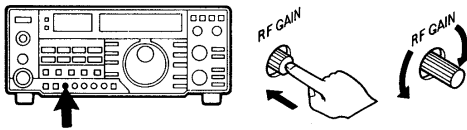

- 1) Select transmit mode with the [XMIT] SWITCH.
- 2) Operate the CW key. The meter movement indicates that a signal is being transmitted.
- 3) Adjust the [RF PWR] CONTROL to obtain suitable output power.

● [BK-IN] : SEMI or FULL

- 1) Select [BK-IN] SWITCH.
- 2) Adjust [DELAY] CONTROL.
 (Semi break-in only)
- 3) Operate CW key.
- 4) Adjust [RF PWR] CONTROL.

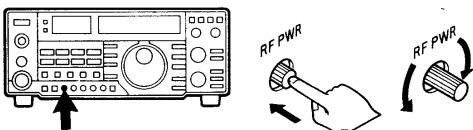

Semi and full break-in functions allow for automatic switching of transmitting and receiving when keying down.

- 1) Set the [BK-IN] SWITCH in the SEMI or FULL position.
 [SEMI] : Semi break-in operation.
 [FULL] : Full break-in operation.
- 2) For semi break-in operation, adjust the [DELAY] CONTROL to set the transmit release delay time to suit your keying speed.
 • When operating using full break-in operation, the delay time is fixed at 5msec. regardless of the [DELAY] CONTROL position.
- 3) Operate the CW key. The meter movement indicates that a signal is being transmitted.
- 4) Adjust the [RF PWR] CONTROL to obtain suitable output power.

6-5 FM OPERATION

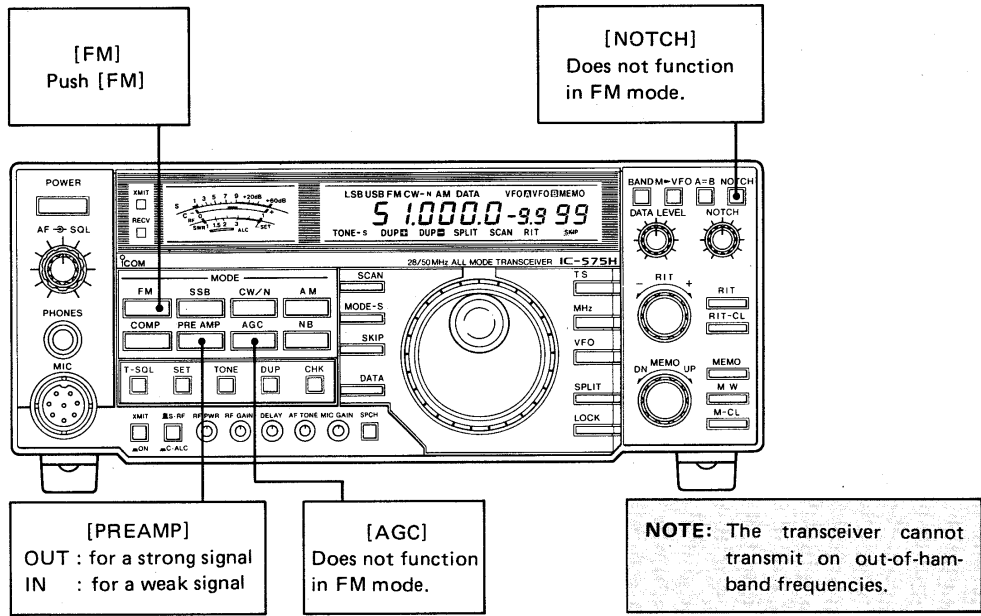

(1) FM RECEIVING

- | | |
|--|--|
| <ol style="list-style-type: none"> 1) Set all controls and switches. 2) Push IN [POWER] SWITCH. 3) Push [FM] SWITCH. 4) Adjust [AF] GAIN and [SQL] CONTROLS. | <ol style="list-style-type: none"> 1) Set all controls and switches as described on p. 21. 2) Push IN the [POWER] SWITCH. 3) Push the [FM] SWITCH to select FM mode. 4) Adjust the [AF] GAIN CONTROL for the desired volume. |
|--|--|

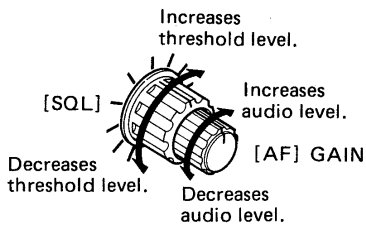

Turn the [SQL] CONTROL clockwise until noise from the speaker is quieted.

- | | |
|--|--|
| <ol style="list-style-type: none"> 5) Rotate TUNING CONTROL and search for a signal. 6) Use ATTENUATOR. 7) Select METER SWITCH. | <ol style="list-style-type: none"> 5) Rotate the TUNING CONTROL and search for a signal. Tune across the signal to peak the meter needle while listening for the most intelligible audio. 6) The [RF GAIN] CONTROL functions as an attenuator up to 10dB in FM mode. Adjust the [RF GAIN] CONTROL if required. 7) Set the METER SWITCH in the [S·RF] or [C·ALC] position. |
|--|--|

■ S·RF : S-meter

■ C·ALC : Center meter

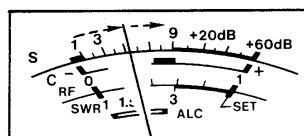

The meter shows signal strength.

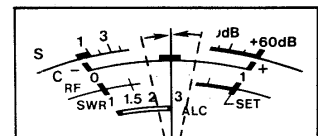

The meter shows signal deviation from the center.

(2) FM TRANSMITTING

NOTE: Listen carefully before transmitting to be sure your transmission will not interfere with any other communications.

The transceiver transmits only on amateur bands 28.0000 ~ 29.7000MHz or 50.0000 ~ 54.0000MHz.

1) Select transmit mode.

2) Set METER SWITCH to OUT position.

3) Adjust [RF PWR] CONTROL.

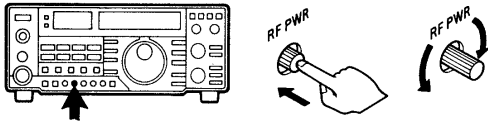

1) Select transmit mode using either the [TRANSMIT/RECEIVE] SWITCH or the [PTT] SWITCH.

2) Set the METER SWITCH to the OUT position. Speak into the microphone using your normal voice level. The meter movement indicates that a signal is being transmitted.

3) Adjust the [RF PWR] CONTROL to a suitable output power level.

● REPEATER OPERATION

1) Push [DUP] SWITCH.

2) Push [TONE] SWITCH.

3) Push [PTT] SWITCH.

4) Check transmit frequency.

To access a repeater the transceiver must be in duplex mode. Some repeaters require a tone signal to open the circuit.

1) Push the [DUP] SWITCH one time for -duplex or two times for +duplex mode and one additional time to return to simplex mode. Offset frequency programming is described on p. 34.

2) Push the [TONE] SWITCH to alternately turn a subaudible tone ON and OFF. Subaudible tone frequency programming is described on p. 35.

- Some transceiver versions include a microphone equipped with a 1750Hz tone call function. Push the [TONE] SWITCH on the microphone for 2 or 3sec. to open a repeater.

3) Push the [PTT] SWITCH and speak into the microphone.

4) Push the [CHECK] SWITCH to monitor the transmit frequency (repeater input frequency) when in duplex mode.

- This allows checking of the signal strength of your contacted station directly without going through a repeater.

If the signal strength is enough for receiving both stations, you should move to a simplex frequency.

6-6 AM OPERATION

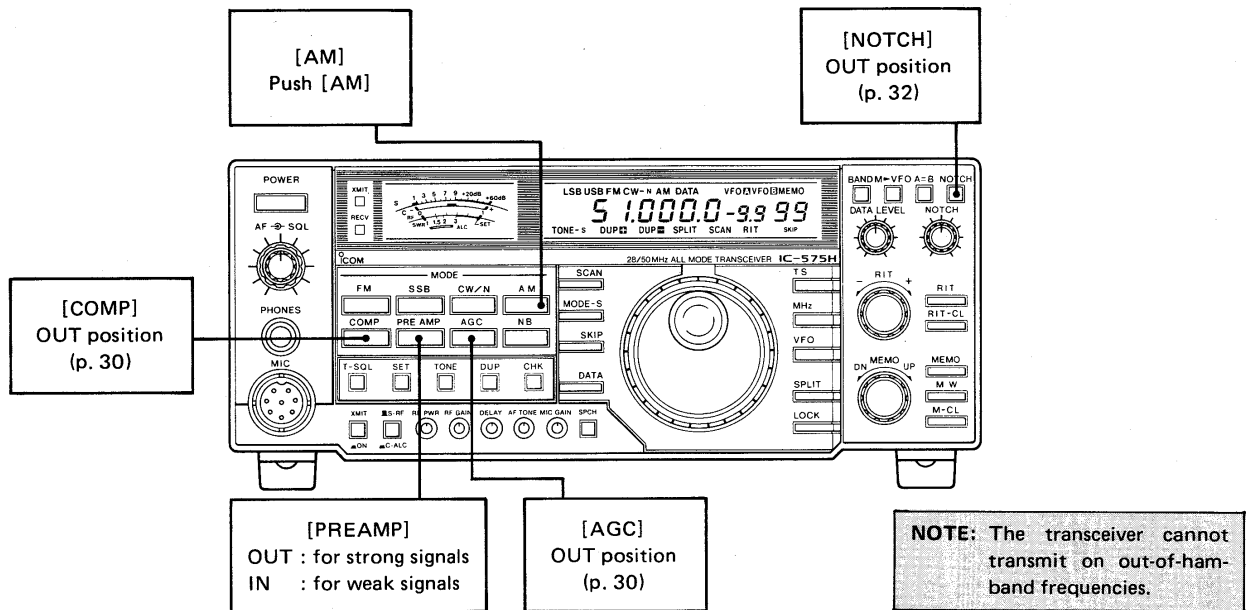

(1) AM RECEIVING

- 1) Push IN the [POWER] SWITCH.
- 2) Select the desired band of operation.
- 3) Push the [AM] SWITCH.
- 4) Adjust the [AF] GAIN CONTROL for a suitable listening level.
- 5) Tune in an AM signal with the TUNING CONTROL using the meter to peak the signal.
- 6) Adjust the [RF GAIN] CONTROL to reduce unwanted weak signals.
- 7) Push the [PREAMP] SWITCH IN when the desired weak signal is received.

(2) AM TRANSMITTING

- 1) Select transmit mode with either the [XMIT] SWITCH or the [PTT] SWITCH on the microphone.
- 2) Set the METER SWITCH to the OUT position.
- 3) Adjust the [RF PWR] CONTROL to obtain the desired output power.
 - IC-575A : Maximum 4W
 - IC-575H : Maximum 25W
- 4) Adjust the [MIC GAIN] CONTROL for a slight indication of the meter needle while speaking into the microphone using your normal voice level.
- 5) The speech compressor [COMP] SWITCH should be turned OFF to prevent overmodulation or distortion.

6-7 PACKET AND AMTOR OPERATIONS

Packet and AMTOR operations require a rapid transmit and receive switching time since they are handshaking communications. The IC-575A/H requires only 5msec. for switching when the [DATA] SWITCH on the front panel is used.

- 1) Connect a terminal unit and any external equipment if required. See p. 18 for proper interconnections.
- 2) Set the switches and controls as explained on p. 21.
- 3) Turn power ON.
- 4) Set mode either to FM, USB, or LSB. CW mode is not acceptable for data communications.
- 5) Set the [DATA LEVEL] CONTROL to the center position.
- 6) Push the [DATA] SWITCH ON. The "DATA" INDICATOR appears.
- 7) Enter commands or data to operate your terminal unit with the IC-575A/H.
- 8) Adjust the [DATA LEVEL] CONTROL, if desired.

6-8 RTTY OPERATION

With the IC-575A/H RTTY contacts may be enjoyed by using AFSK (Audio Frequency Shift Keying). The demodulator used should have 2125/2295Hz or 1700/2125Hz filters for 170Hz or 425Hz shift operation.

- 1) Connect a terminal unit and any external equipment if required. See p. 18 for information regarding interconnections.
- 2) Set the switches and controls as explained on p. 21.
- 3) Turn power ON.
- 4) Set the mode to [LSB].
- 5) Begin sending with your RTTY terminal unit.

• FREQUENCY READOUT

When operating in RTTY, there is a difference between the displayed frequency and the actual operating frequency.

$$\left(\begin{array}{c} \text{Actual operating} \\ \text{frequency} \end{array} \right) = \left(\begin{array}{c} \text{Displayed} \\ \text{frequency} \end{array} \right) - \left(\begin{array}{c} \text{Mark frequency} \\ \text{i.e., 2125Hz or 1700Hz} \end{array} \right)$$

6-9 SSTV OPERATION

Slow Scan Television operation is also possible with the IC-575A/H.

- Connect the CAMERA OUTPUT on your SSTV unit to the ACC(1) CONNECTOR pin 4 or MIC CONNECTOR pin 1.
- An audio output signal is available from pin 5 on the ACC(1) SOCKET. The output level can be changed by S2 on the MAIN UNIT.
- See p. 19 for ACC(1) SOCKET information.

7. FUNCTIONS OPERATION

7-1 SPEECH COMPRESSOR OPERATION

The transceiver has a low distortion, AF speech compressor circuit which provides greater talk power by improving the intelligibility of the transmitted signal over long distances.

1) Set [COMP] SWITCH to ON position.

1) Set the switches and controls as shown in the table.

SWITCH/CONTROL	POSITION
MIC GAIN	Center (12 o'clock)
RF POWER	Max. CCW
COMP	ON (IN)

2) Switch to transmit and speak into the mic.

2) Switch to transmit mode and speak into the microphone using your normal voice level.

3) Adjust [COMP LEVEL] CONTROL if needed.

3) The compressor gain can be adjusted by the [COMP LEVEL] CONTROL on the rear panel.

• To increase the gain, rotate the [COMP LEVEL] clockwise.

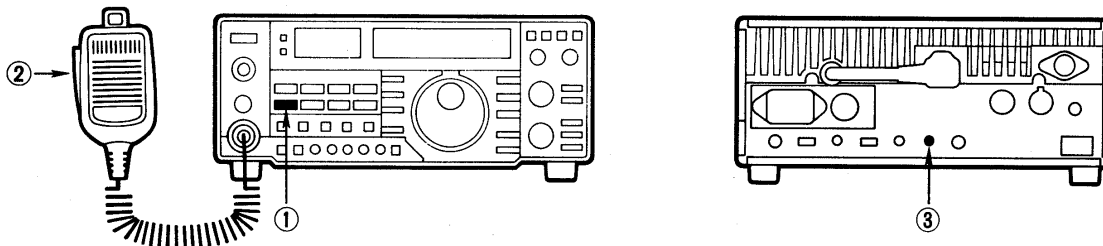

7-2 AGC OPERATION

The transceiver has a fast attack/slow release AGC system which maintains peak voltage of a rectified IF signal from the IF amplifier circuit for a brief period of time.

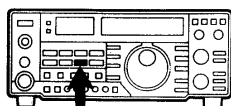

This circuit prevents irritating background noise from being heard during the short pauses in speech. The damping effect of the AGC therefore allows accurate S-meter readings to be taken of peak IF signal strength.

MODE	[AGC] SWITCH
SSB, AM	SLOW (OUT)
CW SSB (with short interval fading)	FAST (IN)
FM	AGC does not operate

7-3 NOISE BLANKER (NB) OPERATION

This operation effectively reduces unwanted pulse-type noise from outside sources such as ignition noise from vehicles.

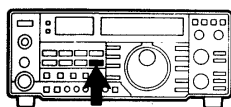

1) Push the [NB] SWITCH.

2) The noise blanker may not work as well when strong signals are on nearby frequencies or when the noise is continuous rather than pulse-type.

7-4 RIT OPERATION

- 1) Push [RIT] SWITCH ON.
Receive : 50.1000MHz
Transmit : 50.1000MHz.

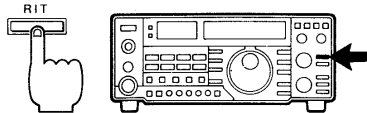

"RIT" appears

- 2) Rotate [RIT] CONTROL CW.
Receive : 50.1099MHz
Transmit : 50.1000MHz

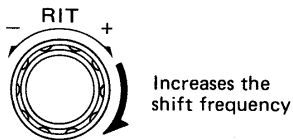

- 3) To clear the RIT shift, push [RIT-CL] SWITCH.
Receive : 50.1000MHz
Transmit : 50.1000MHz



The shift value resets to "0.0".

- 4) To turn OFF the RIT, push [RIT] SWITCH.

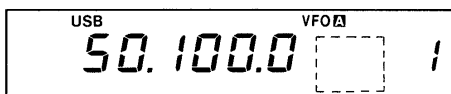

"RIT" disappears.

When using the RIT function, it is possible to shift the receive frequency up to $\pm 9.99\text{kHz}$ without moving the transmit frequency. The shift frequency is in 10Hz steps even when the display changes in 100Hz steps. This is useful for fine tuning and compensating for frequency drift of the transmitting station.

- 1) Push the [RIT] SWITCH to activate the RIT circuit.

- "RIT" and the amount of shift are displayed.

- 2) Rotate the [RIT] INCREMENTAL TUNING CONTROL in the (+) direction to raise the receive frequency, or in the (-) direction to lower the frequency.

- 3) To clear the RIT shift frequency, push the [RIT-CL] SWITCH.

- The shift value resets to "0.0" and the receive and transmit frequencies become the same whether the RIT circuit is ON or OFF.

- 4) To turn OFF the RIT function, push the [RIT] SWITCH again.

- "RIT" and the amount of shift disappear from the FREQUENCY DISPLAY.

- The transmit and receive frequencies are the same as indicated on the FREQUENCY DISPLAY.

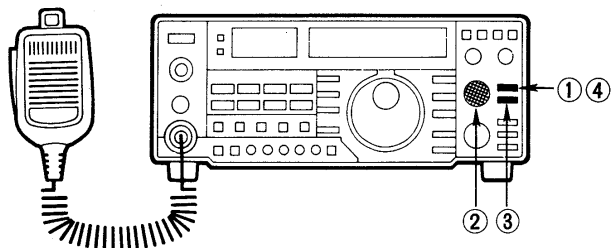

7-5 DATA SWITCH OPERATION

This switch allows you to freely operate digital communications such as AMTOR or packet without time delay.

- The transmit and receive switching time is approximately 5msec. when using the [DATA] SWITCH.
 - The [DATA] SWITCH does not function in CW mode.
- 1) Connect the terminal unit to the transceiver properly.

NOTE: When the [DATA] SWITCH is ON voice communications are not recommended, as the open/close delay time of the squelch circuit is too short.

- 2) Select a mode switch and push the [DATA] SWITCH.
 - "DATA" appears on the FREQUENCY DISPLAY.
- 3) Adjust the [DATA LEVEL] CONTROL for modulation input level.

7-6 NOTCH FILTER OPERATION

- 1) Push [NOTCH] FILTER SWITCH.
- 2) Adjust [NOTCH] FILTER CONTROL.

This circuit provides high attenuation at one particular frequency in the IF passband. It may be used to reduce or eliminate interfering heterodyne signals that fall within the passband of the receiver.

- 1) Push the [NOTCH] FILTER SWITCH to the ON position (IN).
- 2) Adjust the [NOTCH] FILTER CONTROL to minimize interference.

• Notch filter characteristics

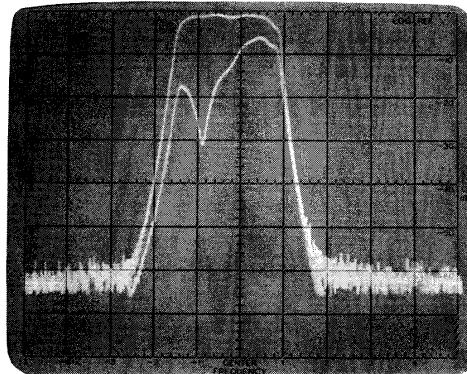

7-7 MICROPHONE UP/DOWN OPERATION

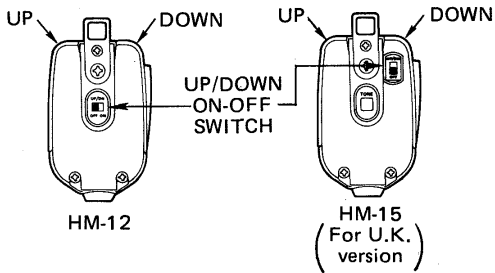

(1) FREQUENCY CONTROL

(2) MEMORY CHANNEL SELECTION

This up/down function is useful for changing the operating frequency when using VFO mode or MEMORY CHANNEL mode.

Microphone UP/DOWN ON-OFF SWITCHES:

- OFF: The [UP] and [DN] (down) SWITCHES on the microphone are disabled to eliminate accidental frequency or memory channel changes.
- ON: The [UP] or [DN] SWITCH can be used to change operating frequencies.

1) Each push of the [UP] or [DN] SWITCH on the supplied microphone changes the operating frequency one increment up or down, respectively.

2) Holding either switch down changes the operating frequency continuously in the same manner as the TUNING CONTROL.

1) When using MEMORY CHANNEL mode, the memory channel can be changed with the microphone up/down switches.

2) The memory channel or the displayed memory channel number changes continuously if the microphone switches are held down.

7-8 SWR READING OPERATION

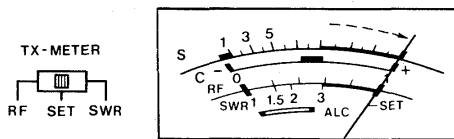

Adjust to "SET" position with [RF POWER] CONTROL

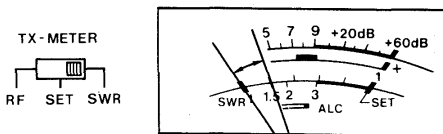

The SWR should be less than 1.5.

The transceiver has a built-in SWR meter to check the antenna matching condition helping avoid problems caused by high SWR.

1) Set the METER SWITCH on the front panel to the [S-RF] position.

2) Set the [TX-METER] SWITCH on the rear panel to the [SET] position.

3) Select FM mode.

4) Rotate the [MIC GAIN] CONTROL fully CCW.

5) Push the [XMIT] SWITCH to the TRANSMIT (IN) position.

6) Adjust the [RF PWR] CONTROL to move the meter needle to "SET" on the SWR scale.

7) Set the [TX-METER] SWITCH to "SWR". Read the SWR from the SWR scale.

8) If the SWR is less than 1.5, the matching condition between the transceiver and your antenna is good.

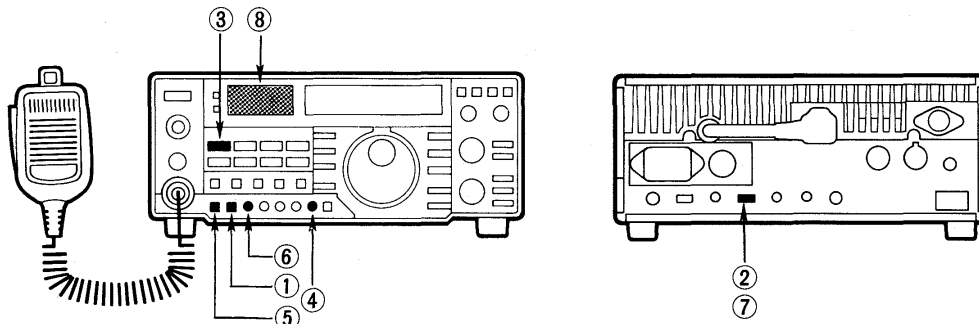

7-9 DUPLEX OPERATION

The purpose of the duplex function is to allow an operator the option of transmitting and receiving on two different frequencies.

The transceiver provides duplex operation using either of the following two methods:

- (1) Duplex operation with user-programmed offset frequency.
- (2) Split operation with VFO A and VFO B.

(1) OFFSET FREQUENCY PROGRAMMING

- 1) Push [DUP] SWITCH.
- 2) Push [SET] SWITCH.

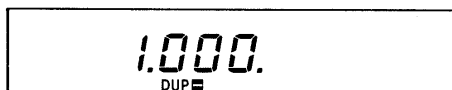

- 3) Set the offset frequency for 100kHz.



- 4) Return to normal operating mode.

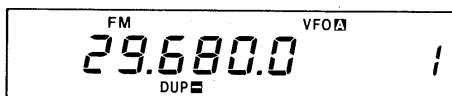

Following is an example for resetting the offset frequency at 100kHz. Refer to p. 27 REPEATER OPERATION for duplex operation.

- 1) Push the [DUP] SWITCH to set duplex mode.
- 2) Push the [SET] SWITCH. The subaudible tone function should be turned OFF when programming the offset frequency.

- 3) Rotate the TUNING CONTROL to "0.100." for the desired offset frequency of 100kHz.

- 4) Push one of the following switches to return to the normal operating mode: [TONE], [DUP] or [CHK].

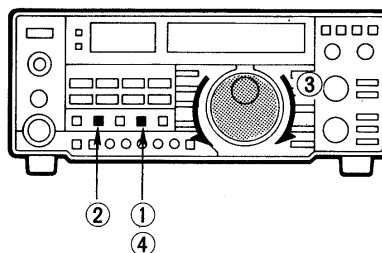

(2) SPLIT OPERATION

Duplex operation is possible using the contents of VFO A and VFO B.

Following is an example for FM 51.0000MHz for receiving and USB 51.1550MHz for transmitting on duplex (split frequency) operation.

- 1) Set VFO A mode and program FM 51.0000MHz.

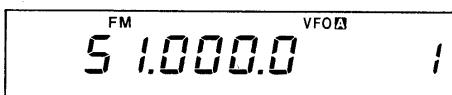

- 2) Set VFO B mode and program USB 51.1550MHz.

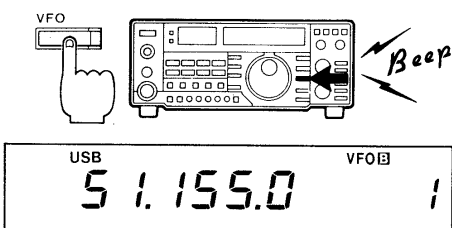

- 1) Push the [VFO] SWITCH to set the transceiver in VFO A mode and set a receive frequency of 51.0000MHz in FM mode.

- 2) Push the [VFO] SWITCH to set the transceiver in VFO B mode and set a transmit frequency of 51.1550MHz in USB mode.

3) Return to VFO A mode.

4) Push [SPLIT] SWITCH.

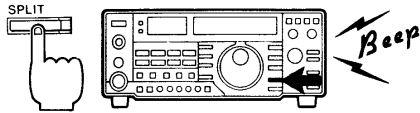

5) Transmit.

6) Receiving : FM 51.0000MHz
Transmitting : USB 51.1550MHz

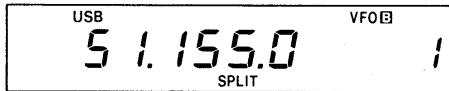

3) Push the [VFO] SWITCH again to return to VFO A mode.

4) Push the [SPLIT] SWITCH to enter the split frequency operation.

• "SPLIT" appears on the FREQUENCY DISPLAY.

5) Push either the [XMIT] or [PTT] SWITCH to transmit.

6) You are now receiving on FM 51.0000MHz and transmitting on USB 51.1550MHz. Push the [VFO] SWITCH once again to receive on USB 51.1550MHz and transmit on FM 51.0000MHz.

Each VFO stores the operating mode in addition to the operating frequency. This allows crossmode contacts to be easily made.

7-10 SUBAUDIBLE TONE ENCODER

1) Push [TONE] SWITCH.

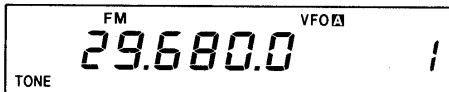

2) Push [SET] SWITCH and rotate TUNING CONTROL.

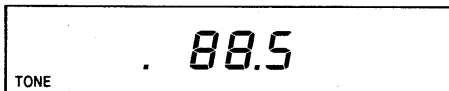

One of 38 different subaudible tone frequencies can be programmed to access a repeater.

1) Push the [TONE] SWITCH to turn ON the tone encoder function.

• "TONE" appears on the FUNCTION DISPLAY.

2) Push the [SET] SWITCH and rotate the TUNING CONTROL to select the desired tone frequency.

3) Push [SET] SWITCH again.

3) Push the [SET] SWITCH again to program the tone frequency. The [TONE] SWITCH alternately turns ON and OFF the tone encoder function.

• When the duplex mode is selected the offset frequency appears on the FUNCTION DISPLAY.

8. MEMORY AND SCANNING OPERATION

The transceiver has ninety-nine memory channels. One frequency, the operating mode, the subaudible tone frequency, VFO A/B, and the duplex condition may be assigned to each memory channel whether the transceiver is in VFO mode or MEMORY CHANNEL mode.

8-1 VFO A AND B SELECTION

- 1) VFO A and VFO B can be selected by pushing the [VFO] SWITCH alternately.
- 2) The parameters in VFO A and VFO B can be made the same by pushing the [A = B] SWITCH.

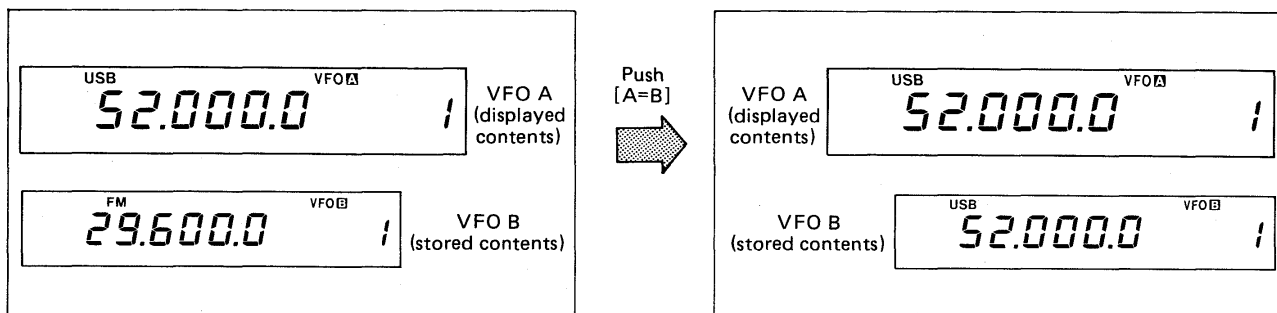

8-2 MEMORY CHANNEL AND VFO SELECTION

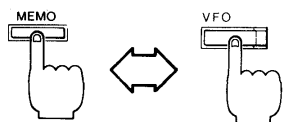

- 1) Push the [MEMO] SWITCH to select MEMORY CHANNEL mode.
 - "MEMO" appears on the FREQUENCY DISPLAY.
- 2) Rotate the [MEMO] CHANNEL SELECTOR CONTROL to select any of the memory channels.
 - When memory channels not yet programmed are selected, only decimal points appear on the FREQUENCY DISPLAY.
- 3) Push the [VFO] SWITCH to return to VFO A or VFO B mode selection.

NOTE: If the [MODE-S] SWITCH is pushed IN, only memory channels with the same operating mode as displayed just prior to pushing the switch are selected when the [MEMO] CHANNEL SELECTOR CONTROL is used.

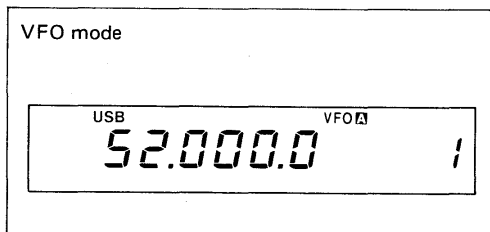

Push [MEMO] →

← Push [VFO]

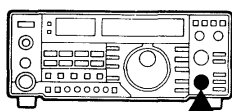
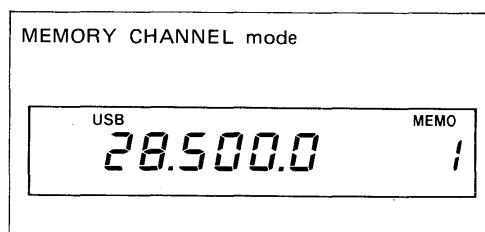

Rotate [MEMO]

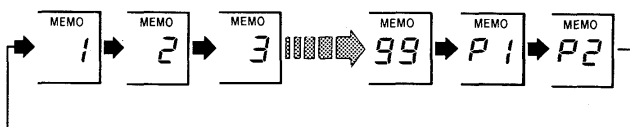

8-3 MEMORY DATA TRANSFERRING

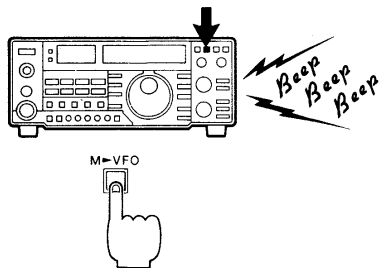

- 1) When the transceiver is in VFO mode, the frequency and modes stored in the memory channel displayed are transferred to the selected VFO.
- 2) When the transceiver is in MEMORY CHANNEL mode, the frequency and mode are transferred to the VFO used immediately before transferring to MEMORY CHANNEL mode.

NOTE: The parameters in the memory channel will not be changed by the [M ▶ VFO] SWITCH. If the displayed memory channel has no parameters (blank status), the MEMORY DATA TRANSFER function will not be activated.

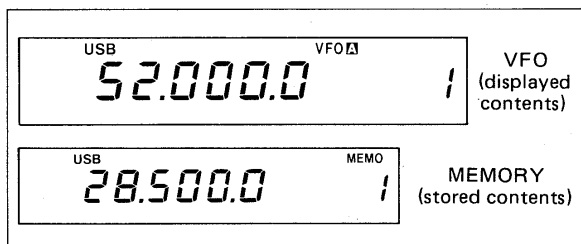

Push [M ▶ VFO]

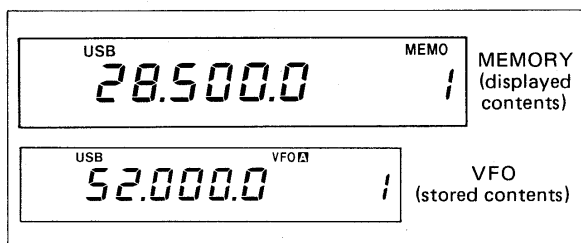
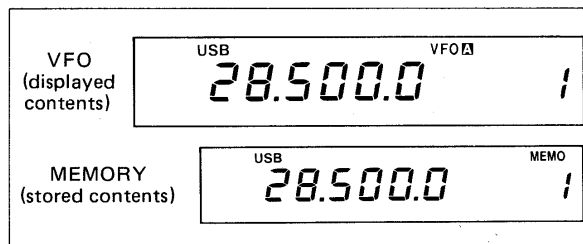

Push [M ▶ VFO]

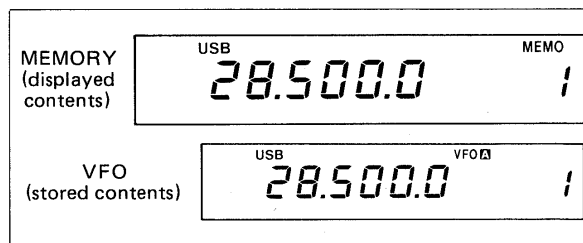

8-4 MEMORY PROGRAMMING

Any frequency, operating mode, subaudible tone frequency, VFO A/B, or duplex condition may be memorized in any memory channel.

Following are instructions for programming 29.6800MHz and FM mode into Memory Channel 88.

- 1) Select operating parameters.

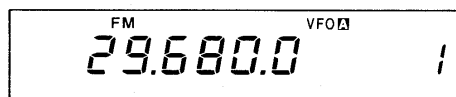

- 2) Select Memory Channel 88.

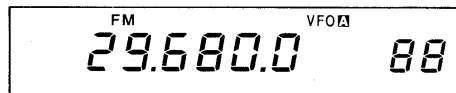

- 3) Push [MW] SWITCH.

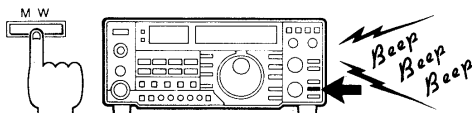

- 1) Set the frequency and mode for 29.6800MHz and FM using the TUNING CONTROL and [FM] MODE SWITCH respectively. VFO A or B may be used while selecting these parameters.
- 2) Select Memory Channel 88 by rotating the [MEMO] CHANNEL SELECTOR CONTROL.
- 3) Push the [MW] SWITCH to program these parameters into Memory Channel 88.

- When the programming is successful, three short beep tones will be emitted.

- 4) Push [MEMO] SWITCH to check contents.

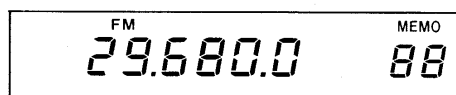

- 4) Push the [MEMO] SWITCH to check the memory channel contents.

- The contents of the selected memory channel are displayed.

8-5 MEMORY CLEARING

- 1) Push [MEMO] SWITCH.

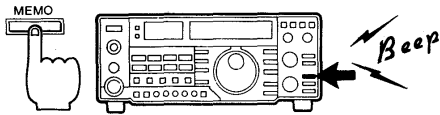

- 2) Select the memory channel to be cleared.

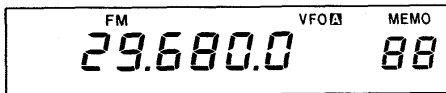

- 3) Push [M-CL] SWITCH.

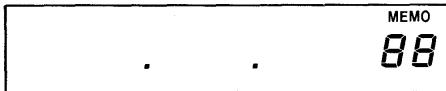

This function is used to clear the information in each memory channel.

- 1) Push the [MEMO] SWITCH to enter MEMORY CHANNEL mode.

- 2) Select the memory channel to be cleared by rotating the [MEMO] CHANNEL SELECTOR CONTROL.

- 3) Push the [M-CL] SWITCH until three beep tones are emitted from the speaker.

- The memory channel is now vacant.

8-6 SCANNING OPERATION

The transceiver comes equipped with four scan functions, providing tremendous scanning versatility at the touch of just a few switches.

SCAN TYPE	OPERATION
MEMORY CHANNEL SCAN	Scans all MEMORY CHANNELS containing information while skipping memories in blank status.
PROGRAMMED SCAN	Repeatedly scans between two user-PROGRAMMED frequencies in the scan range using independent memories P1 and P2 for storage of frequency data.
SELECTED MODE MEMORY SCAN	Repeatedly scans all memory channels containing frequencies in the same MODE as the displayed frequency.
SKIP SCAN	Scans all specified memory channels while skipping unspecified channels and those in blank status.

•SCAN FUNCTION NOTES

① Scan Speed Switch

Switches the scan speed in any scan mode. Slide the switch to the position for the desired speed. The switch is located on the LOGIC UNIT.

② Adjusting Squelch Control

Adjust the [SQL] CONTROL to quiet the noise output from the speaker since the scan will stop only if the squelch is set.

③ Scan Timer

When a signal is received, the scan stops and then starts again after 3 or 10sec. These times depend on the type of signal received.

- 3sec. : A signal of short duration such as pulse signals.
- 10sec. : A signal of long duration such as voice signals.

(1) PROGRAMMED SCAN

The purpose of this scanning function is to monitor a particular section of the band.

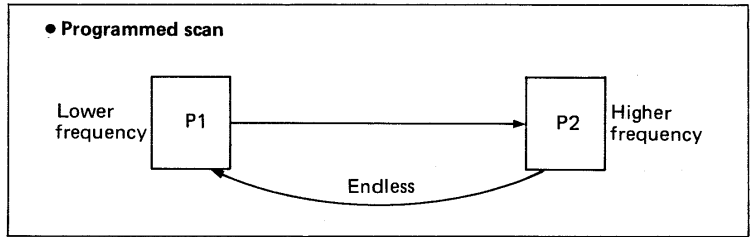

- 1) Store the scan edges.

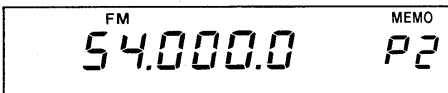
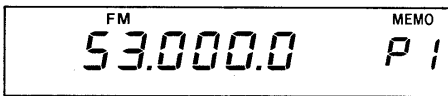

- 2) Select mode and adjust [SQL] CONTROL.

- 3) Push [SCAN] SWITCH.

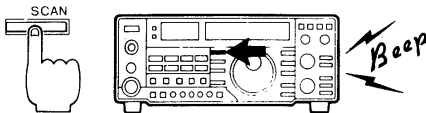

- 4) Scan stops.

- 5) Cancel scan.

- 1) Store the frequencies of the HIGH and LOW scan edges (limits of the desired scanning range) in memory channels P1 and P2.

- Refer to p. 36 for programming memory channels.

- 2) Push the desired MODE SELECTOR SWITCHES and adjust the [SQL] CONTROL to the threshold point.

- 3) Push the [SCAN] SWITCH to start the scan.

- "SCAN" appears and the scan begins scanning upwards.

- 4) When a signal is received the scan stops as described on p. 38 ③ Scan Timer.

- 5) Push the [SCAN] SWITCH or turn the TUNING CONTROL to cancel the scan.

NOTE: Programmed scan does not function if P1 and P2 are programmed for the same frequencies or if either P1 or P2 is programmed with no frequency.

(2) MEMORY SCAN

This scan automatically scans all programmed memory channels except the skip channels described on p. 40.

- 1) Select memory mode and adjust [SQL] CONTROL.

- 2) Push [SCAN] SWITCH.

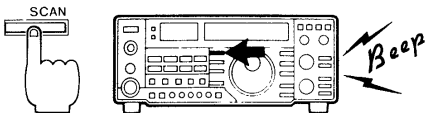

- 3) Scan stops.

- 4) Cancel scan.

- 1) Push the [MEMO] SWITCH to select MEMORY CHANNEL mode and adjust the [SQL] CONTROL to the threshold point.

- 2) Push the [SCAN] SWITCH to start the scan.

- 3) When a signal is received the scan stops as described on p. 38 ③ Scan Timer.

- 4) Push the [SCAN] SWITCH or turn the TUNING CONTROL to cancel the scan.

(3) SELECTED MODE MEMORY SCAN

This scan selectively monitors memory channels programmed with the same mode.

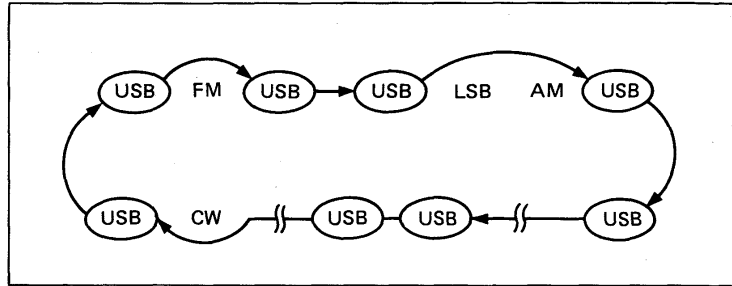

- 1) Select memory mode and adjust [SQL] CONTROL.
- 2) Push desired MODE SELECTOR SWITCH.
- 3) Push [MODE-S] SWITCH.
- 4) Push [SCAN] SWITCH.

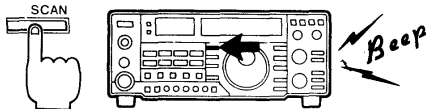

- 1) Push the [MEMO] SWITCH to select MEMORY CHANNEL mode and adjust the [SQL] CONTROL to the threshold point.
- 2) Push one of the MODE SELECTOR SWITCHES to select a mode to receive in.
- 3) Push the [MODE-S] SWITCH to set the selected mode memory scan.
- 4) Push the [SCAN] SWITCH to alternately start and stop the scan.

- If a longer beep tone is emitted, a frequency cannot be stored in memory channels in the desired mode.

(4) SKIP SCAN

This scan skips memory channels you do not wish to scan, repeatedly scanning only the desired memory channels. Refer to (2) MEMORY SCAN on p. 39 for operating procedures.

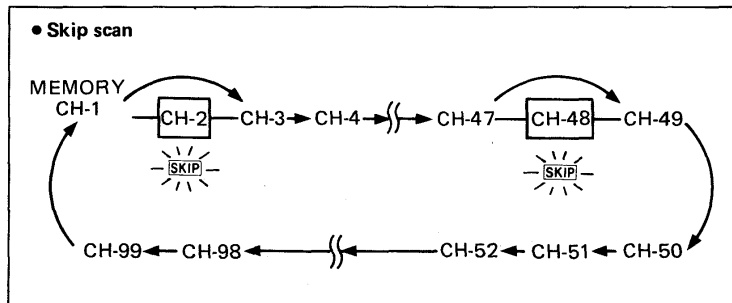

- 1) Select memory channels you wish to skip.
- 2) Push [SKIP] SWITCH.

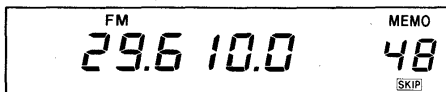

- 1) Select memory channels you wish to program as skip channels using the [MEMO] CHANNEL SELECTOR CONTROL.
- 2) Push the [SKIP] SWITCH to program a selected memory channel as the skip channel.

- "SKIP" appears on the FUNCTION DISPLAY.
- The [SKIP] SWITCH can also be used to cancel a skip channel.

9. MAINTENANCE AND ADJUSTMENT

9-1 MAINTENANCE

(1) CLEANING

If the transceiver becomes dusty or dirty, wipe it clean with a dry, soft cloth. Avoid the use of strong cleaning agents such as benzine or alcohol as they may damage the surfaces.

(2) FUSE REPLACEMENT

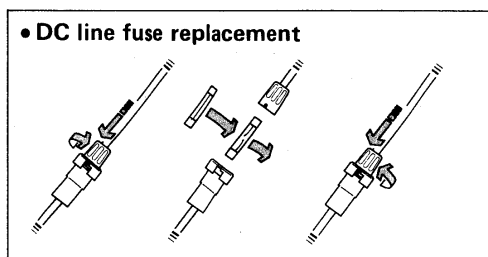
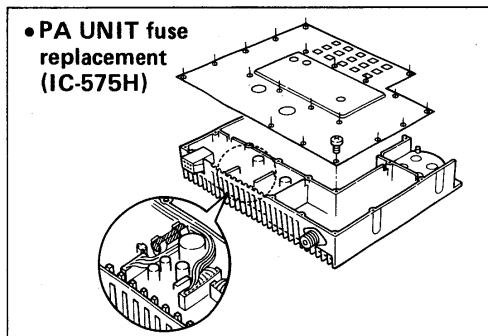

If the fuse blows or the transceiver stops functioning, track down the source of the problem if possible, and replace the damaged fuse with a new, rated fuse.

PA UNIT fuse (for IC-575H):

- All versions F.G.M.B 125V 3A

Rear panel fuse (for IC-575A):

- U.S.A. version. F.G.M.B 125V 5A
- Europe and Australia versions F.G.M.B 250V 3A

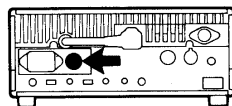

IC-575A
FUSE HOLDER location

DC line (DC cable) fuse:

- IC-575A* 10A
- IC-575H 20A

* DC cable is an option.

(3) BACKUP BATTERY

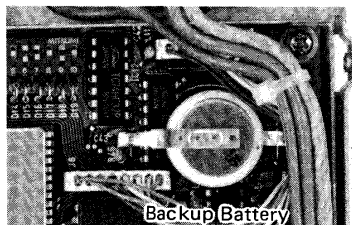

The IC-575A/H has one lithium backup battery for memory contents.

The usual life of the battery is five years after shipment from the factory. If there is a numbering display malfunction, replace the battery.

NOTE: Battery replacement should be done by an authorized Icom Dealer or Icom Service Center.

(4) RESETTING THE INTERNAL MICROPROCESSOR

Occasionally, the FREQUENCY DISPLAY may display erroneous information either during operation or when first applying power. This may, for example, be due to an external cause such as static electricity.

When this sort of problem is encountered, turn OFF the power to the IC-575A/H wait for a few seconds and turn ON the power again. If the problem persists, perform the following procedure.

NOTE: All information programmed in memory channels will be cleared if the transceiver is reset.

1) Turn power OFF, hold down the [M-CL] SWITCH, and turn power ON.

2) The IC-575A/H is now reset.

(5) AUTOMATIC PROTECTOR CIRCUIT (IC-575H)

A built-in protector circuit automatically holds transmit output power at half of maximum power when operating the transceiver continuously at maximum power. This protects the final transistors from overheating.

9-2 ADJUSTMENTS

(1) BRAKE ADJUSTMENT

The TUNING CONTROL tension may be adjusted to the operator's preference. The screw adjustment is located on the bottom side of the transceiver cabinet below the TUNING CONTROL. The method for adjustment is as follows:

- 1) Rotate the TUNING CONTROL continuously and smoothly in one direction.
- 2) Adjust the brake adjustment screw either CW for tighter tension, or CCW for looser tension as desired.

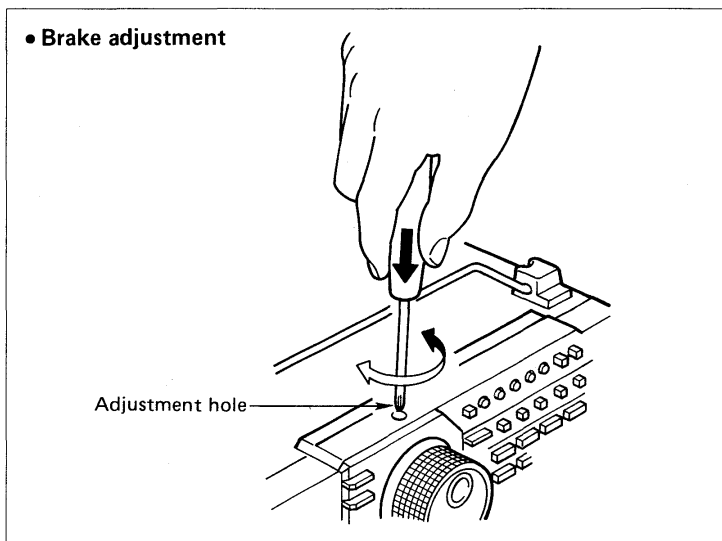

(2) DISPLAY LIGHT DIMMER ADJUSTMENT

The transceiver has an illuminated FREQUENCY DISPLAY for easy reading in dim or no light situations. The light intensity may be varied to suit the ambient light conditions.

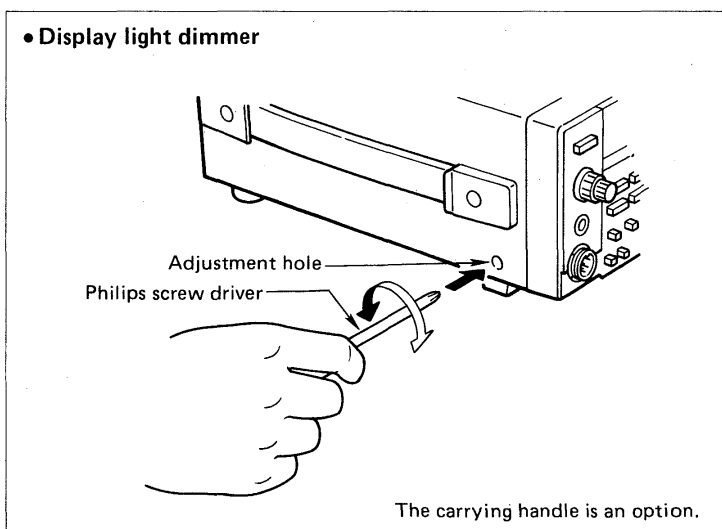

(3) BEEP SOUND LEVEL ADJUSTMENT

The level of the beep sound which is emitted when the specified switches are pushed can be adjusted by R253 on the MAIN UNIT.

- CW rotation of R253 increases the sound level.
- See SECTION 10 INSIDE VIEWS for the location of R253.

10. INSIDE VIEWS

The following adjustment points have been thoroughly adjusted prior to the transceiver leaving the factory. The following should be regarded as reference material. These pictures show the IC-575A.

■ MAIN AND RF-YGR UNITS SIDE

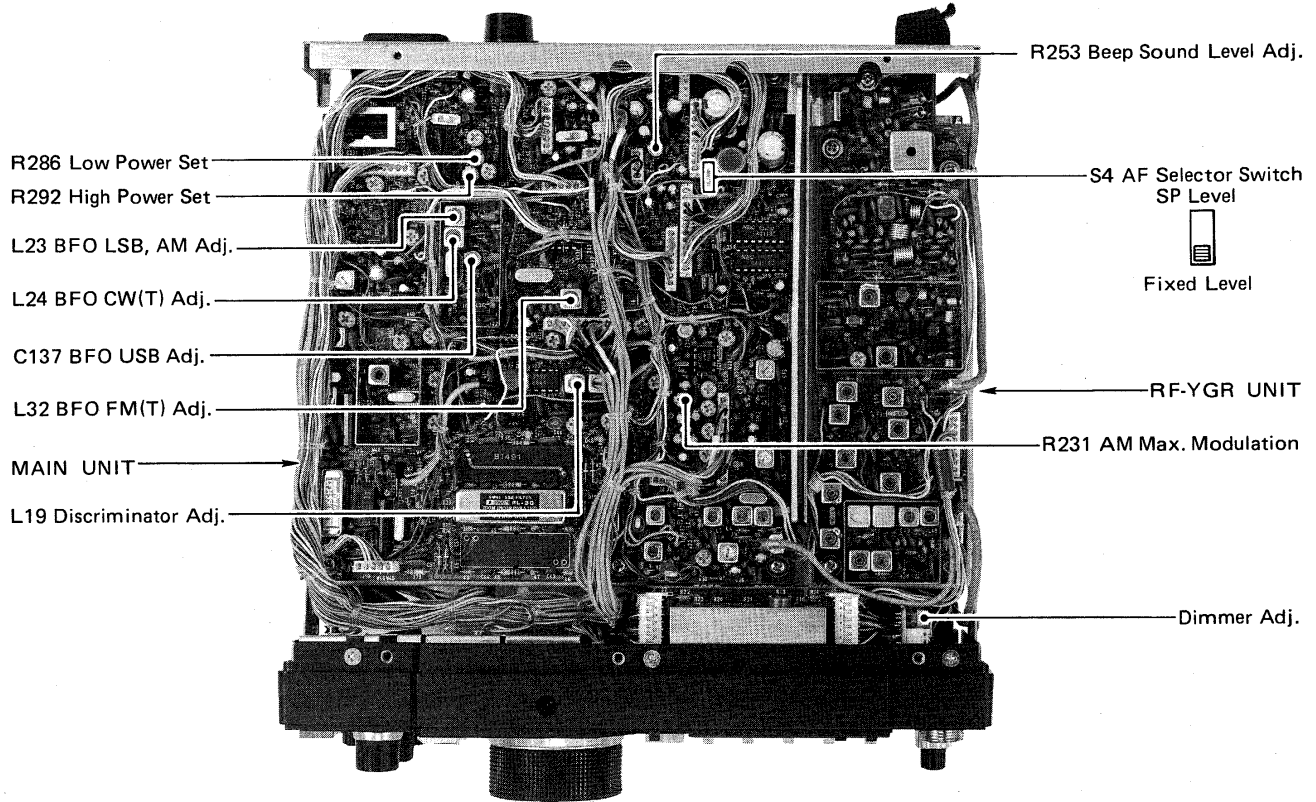

■ PLL AND LOGIC UNITS SIDE

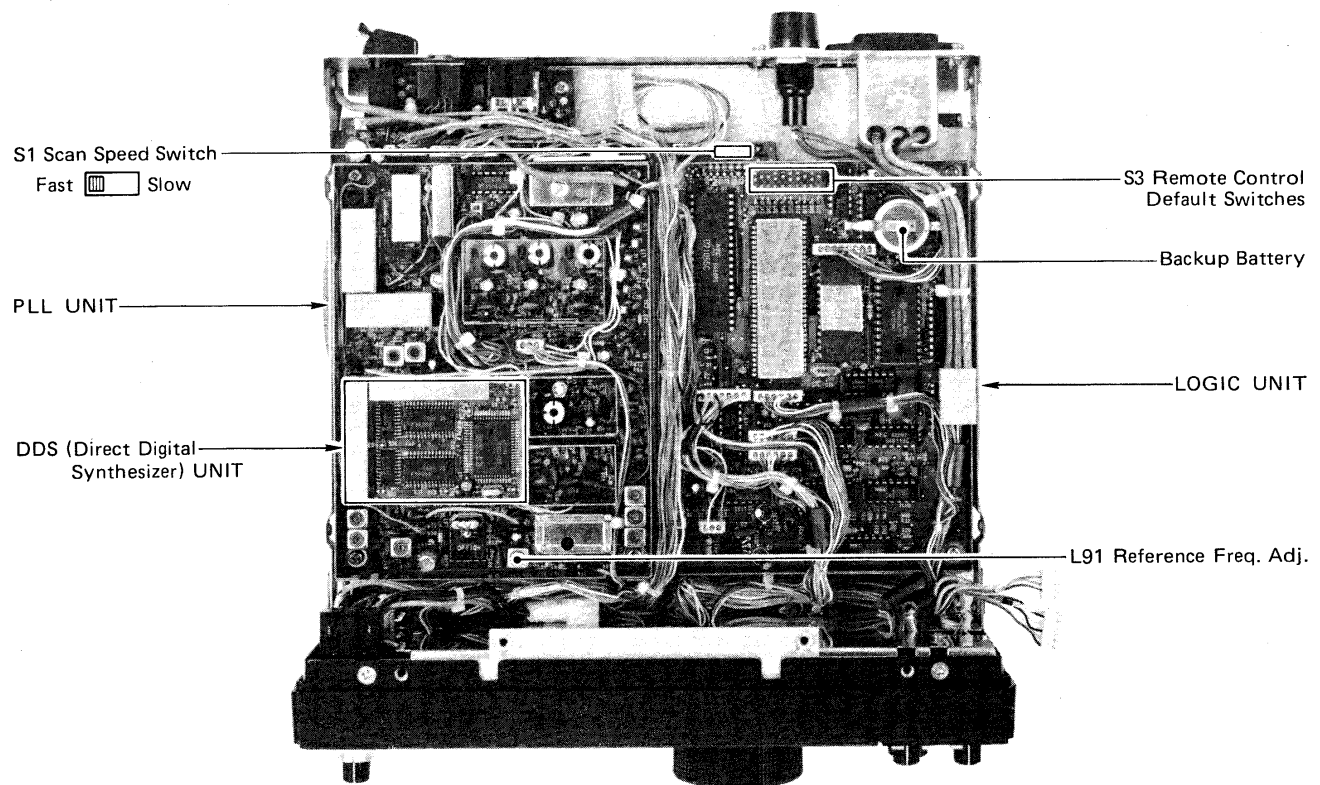

The above pictures show the IC-575A without shield covers.

11. OPTIONS INSTALLATIONS

■ TRANSCEIVER DISASSEMBLY

- 1) Remove the top cover. The PA UNIT is located here.
- 2) Remove the bottom cover. The MAIN and RF-YGR UNITS are located here.
- 3) Remove the PA UNIT. The PLL and LOGIC UNITS are located underneath the PA UNIT.

■ MAIN AND RF-YGR UNITS

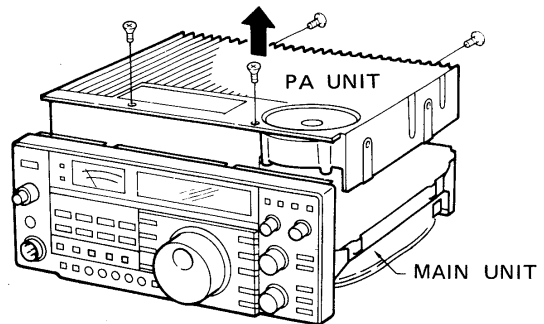
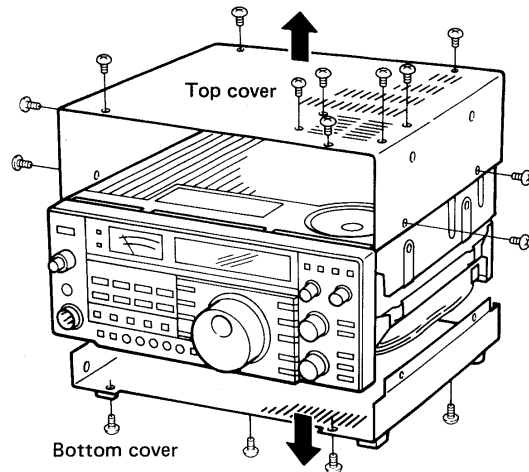
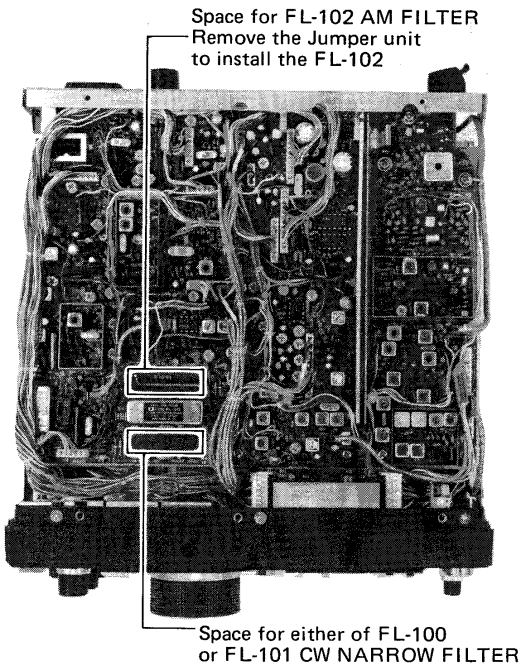

■ PLL AND LOGIC UNITS

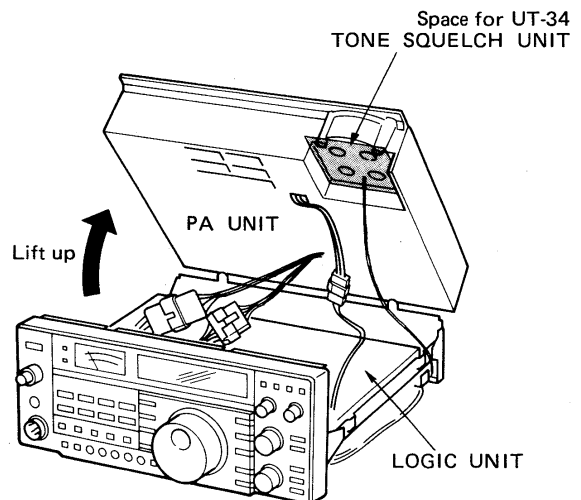
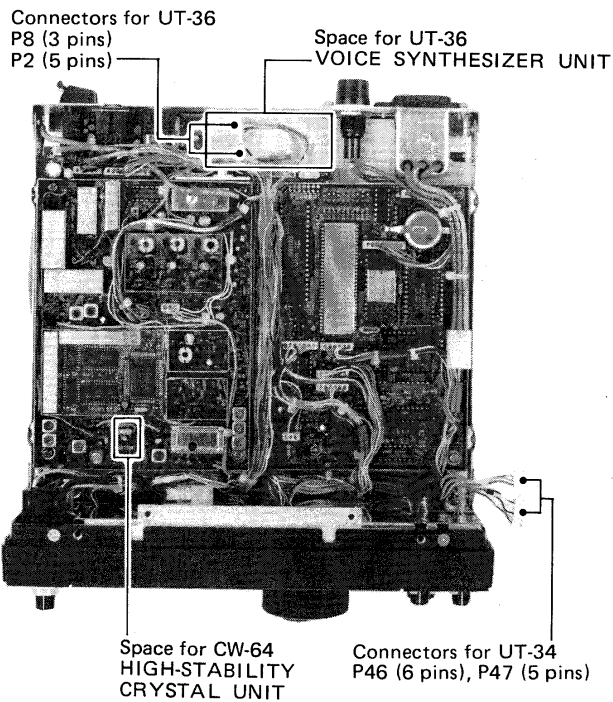

■ **UT-34**
TONE SQUELCH UNIT

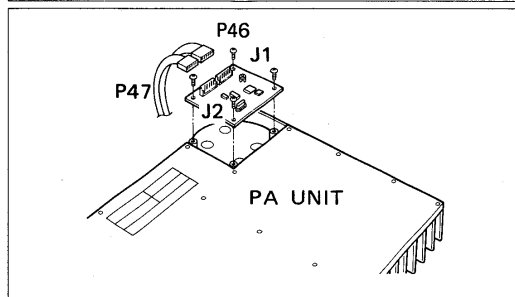
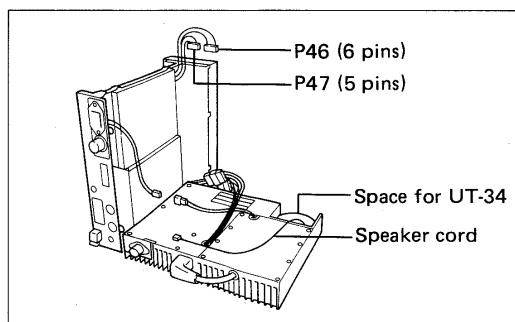

The UT-34 TONE SQUELCH UNIT provides you with interference-free communication with other stations equipped with a tone squelch system.

- The unit should be installed in the designated spot behind the internal speaker on the PA UNIT.

- 1) Remove both the top and bottom covers.
- 2) Remove the PA UNIT.
- 3) Install the UT-34 and connect P46 (6 pins) from the MAIN UNIT to J1 on the UT-34.
- 4) Connect P47 (5 pins) from the LOGIC/FRONT UNITS to J2 on the UT-34. Replace the PA UNIT and covers.
- 5) Refer to the UT-34 instruction sheet for operating instructions.

■ **UT-36**
VOICE SYNTHESIZER UNIT

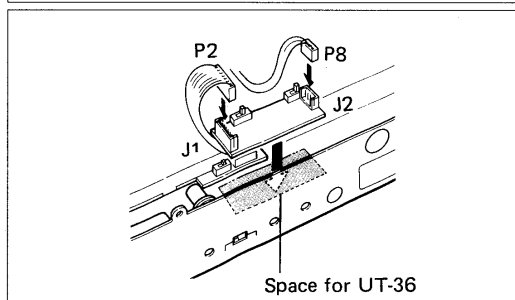
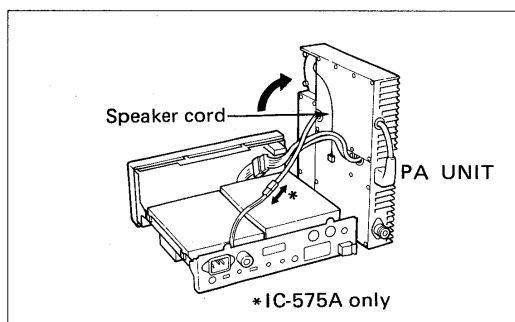

The voice synthesizer announces the displayed frequency when the [SPCH] SWITCH on the front panel is pushed.

- The UT-36 VOICE SYNTHESIZER UNIT should be installed on the bottom side as shown in the diagram.

- 1) Remove the top and bottom covers.
- 2) Remove the PA UNIT.
- 3) Remove the protective paper from the back of the UT-36 to expose the adhesive strip, and install the unit in the location shown in the bottom view of the transceiver.
- 4) Connect P8 (3 pins) from the MAIN UNIT to J2 on the UT-36.
- 5) Connect P2 (5 pins) from the LOGIC UNIT to J1 on the UT-36.
- 6) Replace the top and bottom covers.
- 7) Refer to the UT-36 instruction sheet for operating instructions.

■ **FL-100/FL-101**
CW NARROW FILTER
FL-102
AM FILTER

These optional filters provide comfortable interference-free CW and AM communications.

- Refer to p. 44 for installation location of filters.

NOTE: Be sure the optional filters are installed in the proper direction.

■ **CR-64**
HIGH-STABILITY
CRYSTAL UNIT

Remove X1 on the PLL UNIT and then install the CR-64 (See p. 44) and perform the following:

- 1) Remove P1 from J5 on the RF-YGR UNIT and connect a frequency counter to P1.
- 2) Set display frequency to 54.0000MHz and select FM mode, then adjust L91 on the PLL UNIT to 124.4515MHz.

12. BLOCK DIAGRAMS

IC-575A

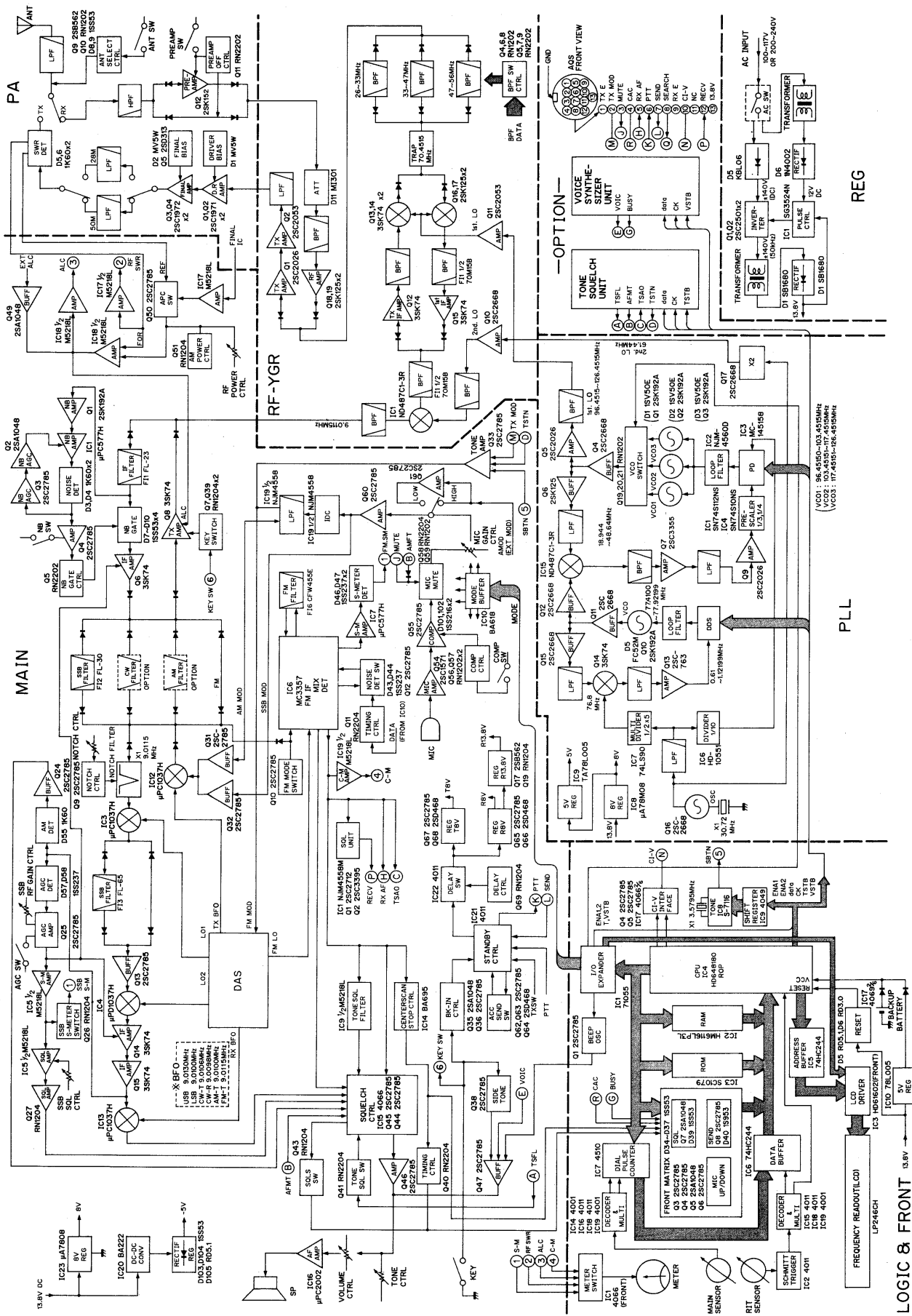

IC-575H

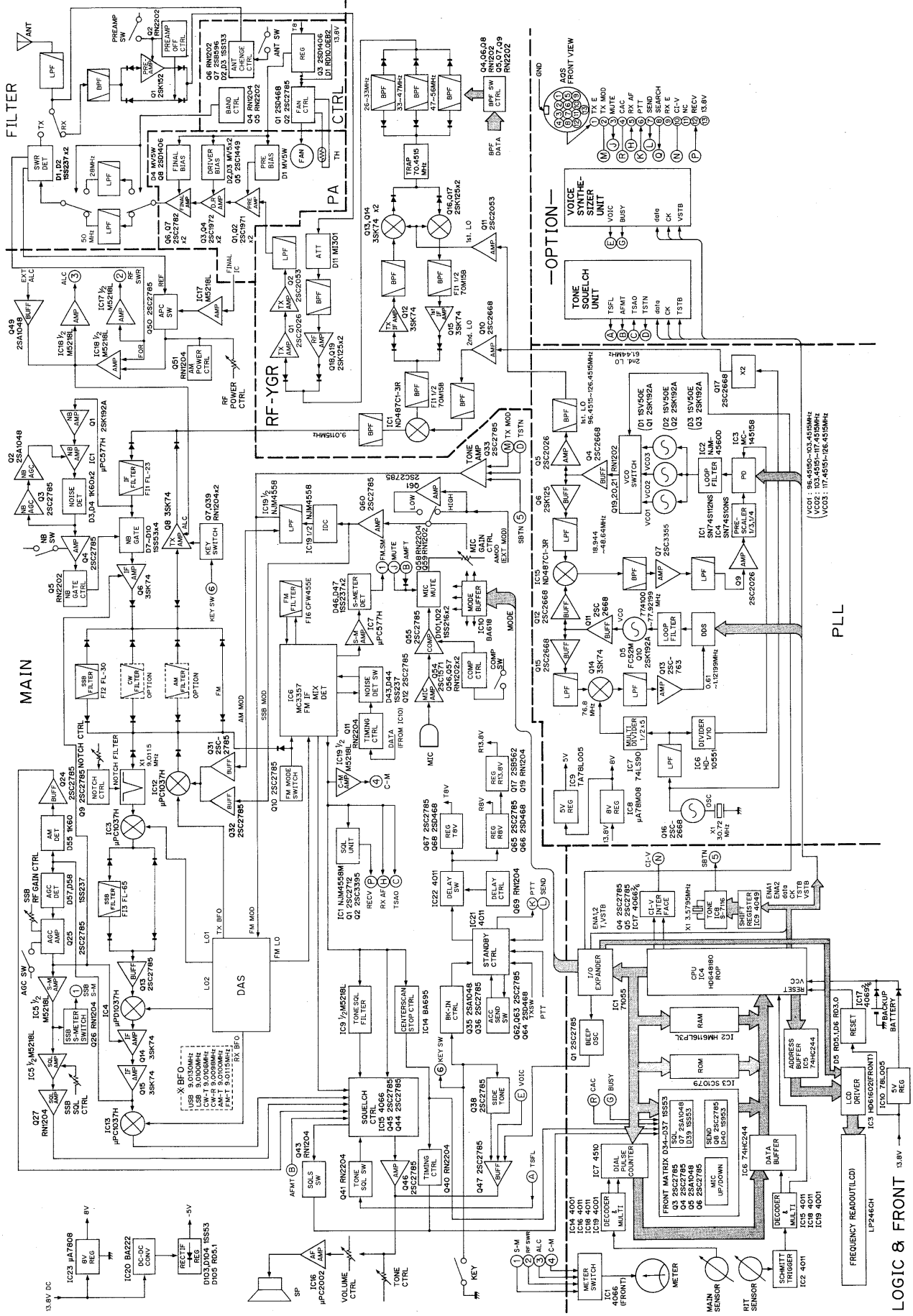

13. SPECIFICATIONS

■ GENERAL

- Frequency coverage : Receive 26.0000 ~ 56.0000MHz
Transmit 28.0000 ~ 29.7000MHz
50.0000 ~ 54.0000MHz
- Number of memory channels : 99 channels plus P1 and P2
- Antenna impedance : 50Ω unbalanced
- Frequency stability : ±5ppm (0°C ~ +50°C)
- Power supply requirement : 13.8V DC ±15%
- Current drain (at 13.8V DC) : Transmitting

	IC-575A		IC-575H	
U.K. versions	5.2A (at 10W)	3.0A (at 1W)	15A (at 50W)	5.5A (at 5W)
Other versions	5.2A (at 10W)	3.0A (at 1W)	20A (at 100W)	8.5A (at 10W)

Receiving At maximum audio output 1.6A
Squelched 1.4A

- Dimensions : 241(244)(W) x 95(108)(H) x 239(277)(D)*mm * IC-575A: 239(295)(D)
Bracketed values include projections.
- Weight : 6.1kg
- Usable temperature range : -10°C ~ +60°C

■ TRANSMITTER

- Emission modes : FM (F3), AM (A3), SSB (A3J), CW (A1)
- RF output power

	IC-575A		IC-575H	
Versions	U.K.	Others	U.K.	Others
FM, SSB, CW	1 ~ 10W	1 ~ 10W	5 ~ 50W	10 ~ 100W
AM	1 ~ 4W	1 ~ 4W	5 ~ 25W	10 ~ 25W

continuously adjustable

- Modulation system : FM Variable reactance frequency modulation
SSB Balanced modulation
AM Low power modulation
- Maximum frequency deviation : ±5kHz (FM mode)
- Spurious emissions : More than 60dB below peak output power
- Carrier suppression : More than 40dB below peak output power
- Unwanted sideband : More than 40dB down with 1000Hz AF input
- Microphone impedance : 600Ω

■ RECEIVER

- Receive system : SSB, CW, AM Quadruple conversion superheterodyne
FM Triple conversion superheterodyne
- Receive modes : FM (F3), AM (A3), SSB (A3J), CW (A1)
- Intermediate frequencies : 1st 70.4515MHz (FM, SSB) 70.4506MHz (CW) 70.4500MHz (AM)
2nd 9.0115MHz (FM, SSB) 9.0106MHz (CW) 9.0100MHz (AM)
3rd 455kHz (All modes)
4th 9.0115MHz (SSB) 9.0106MHz (CW) 9.0100MHz (AM)
- Sensitivity (PREAMP SWITCH ON) : FM Less than 0.25μV for 12dB SINAD
Less than 0.35μV for 20dB NQL
SSB, CW Less than 0.13μV for 10dB S/N
AM Less than 1.0μV for 10dB S/N
- Squelch sensitivity (PREAMP SWITCH ON) : FM Less than 0.1μV for 10dB S/N
SSB, AM Less than 0.7μV
- Selectivity : FM 15.0kHz/-6dB 30.0kHz/-60dB
SSB, CW 2.3kHz/-6dB 4.0kHz/-60dB
AM 6.0kHz/-6dB 15.0kHz/-60dB
- Spurious response rejection : More than 70dB
- Audio output impedance : 8Ω
- Audio output power : More than 2W at 10% distortion with an 8Ω load
- RIT variable range : ±9.99kHz

All stated specifications are subject to change without notice or obligation.

14. OPTIONS

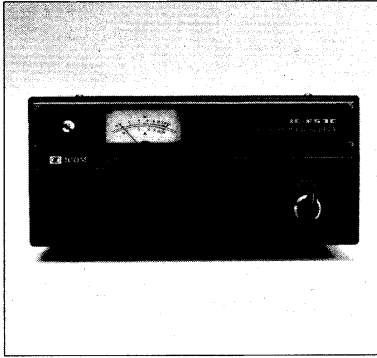

IC-PS30
AC POWER SUPPLY
(13.8V, 25A)



PS-55*
AC POWER SUPPLY
(13.8V, 20A)

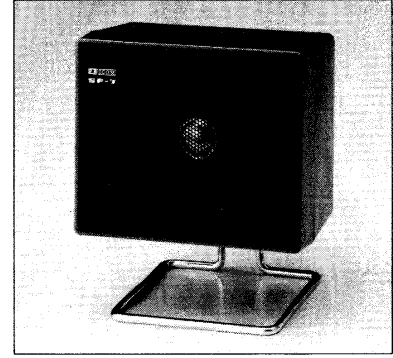

SP-7*
EXTERNAL SPEAKER

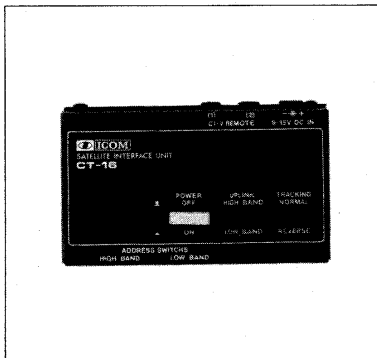

CT-16
SATELLITE INTERFACE UNIT

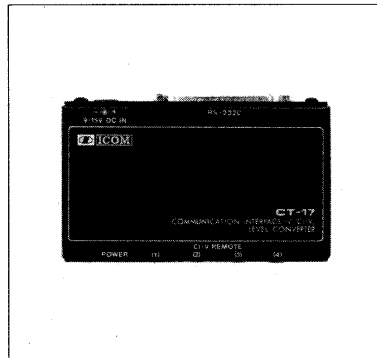

CT-17
CI-V LEVEL CONVERTER

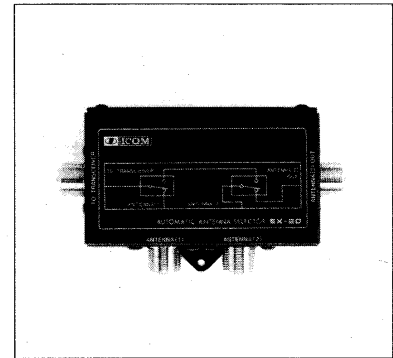

EX-20
AUTOMATIC ANTENNA
SELECTOR

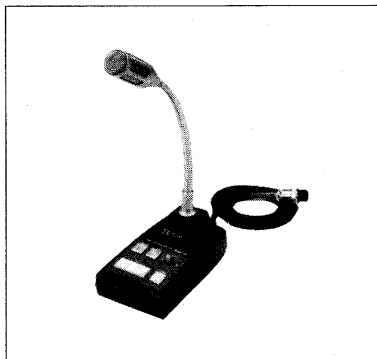

SM-8
DESK MICROPHONE



SM-10
COMPRESSOR/GRAPHIC
EQUALIZER DESK TOP
MICROPHONE

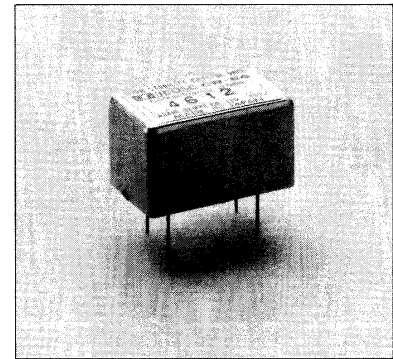

CR-64
HIGH-STABILITY
CRYSTAL UNIT

UT-34	TONE SQUELCH UNIT
UT-36	VOICE SYNTHESIZER UNIT
FL-100	CW NARROW FILTER (500Hz/-6dB)
FL-101	CW NARROW FILTER (250Hz/-6dB)
FL-102	AM FILTER (6kHz/-6dB)
IC-MB5	MOBILE MOUNTING BRACKET
MB-23	CARRYING HANDLE
AH-610	28/50MHz DUAL BAND ANTENNA

*Matching style and size with IC-575A/H.

Count on us!

